

COACHING GRASSROOTS FOOTBALL



Better Coaches, Better Football



©TM
FOOTBALL
FEDERATION
AUSTRALIA

Legend



= Cone



= Bib



= Ball



= Ball Path



= Player Path



= Player Path



= Dribbling Ball Path



= Team Red Player



= Team Yellow Player



= Team Blue Player



= Coach



FOOTBALL
FEDERATION
AUSTRALIA



COACHING GRASSROOTS FOOTBALL

**Better Coaches,
Better Football**

Football Federation Australia
Coach Education 2007

Written by

Kelly Cross

National Coach Education Manager

Football Federation Australia

© Football Federation Australia Limited 2007

All rights reserved

No part of this book may be reproduced without the FFA's prior consent.

Foreword

This book is a very useful tool for coaches (parents) working in Grassroots Football. It respects the needs and requirements of young players finding their way into the game of football.

Under consideration of the psychological background of youngsters, comprehensive recommendations for efficient training are offered.

Also, adults with little or no experience in coaching will understand what training at this early stage of development is all about. Consequently both parties will be beneficiaries, the players and the adults involved.

Holger Osieck

Head of Technical Development

FIFA

(Fédération Internationale de Football Association)

Preface

Football, more than any other sport, is a game for everybody. Male and female players, from the elite to the recreational level, are playing the world game in ever-increasing numbers in Australia.

Football is also a game that allows for all ages to be involved.

Of all the age-groups playing football, it is the young that are the most important. These players are the foundation of the whole of football; without young players, football has no future.

This book is aimed at the people responsible for nurturing these young players. By making their job easier, and by assisting them to design appropriate training sessions, the book will be a major contributor to Australia's football development.

The overarching focus of this publication is the provision of 'quality football experiences.' Kids must enjoy football, in a safe environment, and they need to feel valued as human beings. Moreover, the volunteer coaches who play such an important role in our game need to feel confident about the job they are doing.

I believe this book will help players and coaches achieve those goals, and will make sure they have fun doing it!

Football Federation Australia is committed to servicing the game of football at all levels. In an era of amazing achievement at the top end of the game, with our Socceroos and Matildas performing so well, this book confirms our awareness of the equal importance of Grassroots Football.

On behalf of Football Federation Australia, I would like to thank you for your dedication to the development of Australia's young players.



Ben Buckley

Chief Executive Officer

Football Federation Australia

Contents

Introduction	2
What Is Coaching Kids All About?	4
Organise Fun Practices!	5
Enjoyment Is The Thing, Not Winning	6
What tools do I need?	7
Personal Skills	7
Organisation Skills	9
What are the ingredients of a Kids' Training Session?	10
● The Beginning	11
- Warming Up & Stretching	11
• General Movement	21
• Tagging Games	36
• Ball Mastery	39
● The Middle	44
• Passing & Receiving	45
• Dribbling	56
• 1v1	60
● The End	67
• Shooting Games	68
• Small-sided Games	73
- How To Keep The Fun Going	79
- Cool down	80
Putting it all together – How to plan your sessions	81
Sample Sessions U-5/U-6	85
Sample Sessions U-7/U-8	86
Sample Sessions U-9/U-10	87
Circuits	88
Managing Children's Behaviour	89
Making best use of your training area	91
What are the Secrets of Successful Kids Coaching?	92
'What About Defending?'	94
'What about Goalkeeping?'	95
The 10 Commandments	96
Try Not To...	97
FFA Statutes	98
The FFA Coach Education Pathways	100
Acknowledgements & References	102
Where To Go From Here?	103
Contacts	104

Introduction

This book is for community football coaches who are involved with players aged between 5 and 10.

The coaches of these teams are usually interested parents and volunteers. Their involvement will often stem from a desire to help their own child and the team their child plays in.

FFA has produced this book to help these vital members of the football family, the volunteer coaches, to perform their crucial role as well as possible.

With around 15,000 registered teams in the U-5 to U-10 age bracket, these coaches are nurturing the future of Australian football; it is the hope of FFA that, together, we will be helping to produce whole generations of players that develop a lifelong passion for this great game.

This book is designed to accompany and complement the FFA Grassroots Football Certificate course. It is written to cater for all coaches of kids' teams, regardless of their experience and the level of ability of their players. Accordingly, there is a flexible approach to the content of training sessions. A suggested format is outlined, and it is intentionally simple, breaking a session down into three components:

The Beginning

The Middle

The End

The relevant sections for each component have been given traffic-light colours for ease of reference, green for 'the beginning' ('go!'), amber for the 'middle' and red for 'the end' ('stop!')

Within each of the three components, we have tried to simplify the coach's job of content selection by prescribing a maximum of three 'subject areas', and giving a range of games and practices.

The coach is encouraged to experiment and find the 'right' blend of practices for his or her team, using the three-component framework and the games and practices contained in the book.

Further guidance is provided in 'Putting it all together' (Page 81) . The table gives some age-appropriate suggestions (e.g. 'with 5-6 year-olds, do less of this and more of that; with 7-8 year-olds, do more of this and less of that')

Some sample 6 week programs have been included, to show how sessions can be constructed.

A special feature of this book is the 'quick reference' fold out section at the back. Guidelines for putting sessions together and the diagram legend are easily accessed, making the planning of training sessions far easier.

This book is evidence of FFA's commitment to service every level of football, and we believe it has the potential to have a positive effect on large numbers of people in the game.

Introduction

By following the guidelines in this book, coaches will feel better about the job they are doing, and players will enjoy themselves, while both are developing the necessary skills to improve.

This is in line with the FFA Coach Education slogan:

'better coaches, better football'

It is not an exaggeration to state that Grassroots coaches have perhaps the biggest influence on the future of football in Australia. By conducting appropriate training sessions for the youngsters in your care, you really do 'touch the future'. Your commitment to the task is appreciated by FFA and the States and Territories of Australia, and by using the guidelines in this book we feel sure your players will appreciate it too.

Enjoy the experience!

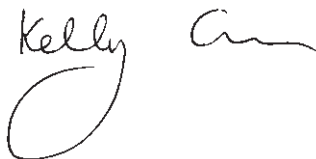
A handwritten signature in black ink, consisting of the name 'Kelly' followed by a stylized surname 'Cross'.

Kelly Cross
National Coach Education Manager
Football Federation Australia

What is coaching kids' all about?

Not so long ago, children learned football by playing the game for hours on end, on the street or in the park, making their own rules. It was 'free play', and they played because they enjoyed it. There were no adults to 'interfere'.

For a whole host of reasons, street football has virtually disappeared. The challenge for coaches of our youngest players in today's world is to re-create that environment of 'fun' and 'freedom', in order to deliver the learning experiences that street football used to provide. We believe that this approach will give thousands of young footballers enjoyable, active football experiences, and hopefully foster a love and passion for the game that will last a lifetime.

And there is every chance it will help us produce more 'creative' players and 'skilful dribblers'; players that can make a difference in a game, that people love to watch.



Organise fun practices!

Perhaps the first and most important step is to take the word 'coach' out of your mind. Your role is summed up in the above title: see yourself as an 'ORGANISER OF FUN PRACTICES.'

It is a mistake, made far too often, for kids' coaches to imitate the coaches they see on television; in fairness, these are usually the only models we have to copy, but unfortunately, the job of a high-profile coach in a professional team bears absolutely no resemblance to the job of a kids' coach. Your FFA Grassroots Football Certificate presenter is a much better model to imitate.

As soon as you think of yourself as an 'organiser', or a 'facilitator of learning', you start to see the role in its true light.

Your job is to plan and organise fun practices.

Then . . . LET THEM PLAY!

We will help you select practices that also have a purpose in the long-term development of young players.

The practice is the teacher, and the kids will learn from the experiences provided.

Remember: teaching young players and watching them develop can give the same, if not greater, satisfaction as winning trophies and medals with senior players.

'Mistakes are often made at the basic training and development stage. The coaches are responsible for this, because they think they are working with professional teams.'

Johann Cruyff, (Holland) world football legend.

There are thousands of possible games and practices for football training. This book contains a selection, and it is designed to give an idea of the many types a coach can use. There is no suggestion that these are the only ones you should use. You may even be inspired to invent some of your own!

Enjoyment Is The Thing, Not Winning!

When the children play games against other teams (and also when they are training) kids need a fun environment where they are free from fear and can play without any pressure on them. At the younger ages, the game result should be irrelevant.

If the emphasis is on winning matches, and winning the whole competition, the development process is doomed to failure and the fun of junior play is replaced by the pressures and frustrations of adult football.

A study of youth sport values showed that the most important values were;

- enjoyment
- personal achievement

The least important was

- winning

The junior coach must value above all else the individual development and welfare of every single player.

Research has shown that the main emphasis should be for the child to experience fun and excitement. Kids at this age are still 'sampling' many sports and activities; football coaches can have a huge impact on which sport the child will choose.



What 'tools' do I need?

There are a range of tools that all football coaches need, but at this level, the two main tools you need are:

PERSONAL SKILLS & ORGANISATION SKILLS

Let's look at each of them:

Personal Skills

Be enthusiastic!

If you look like you're having a good time, it will often follow that the kids will have a good time. Try to show the kids that there is no place you'd rather be right now than on the field with your players.

Be friendly!

The kids need to feel that you are on their side, to be a friend as well as a mentor. Make sure you greet every player on arrival, and say goodbye to every player, thanking them for their efforts in the session.

Show your sense of humour!

'Fun' is the key word; they're not preparing for the World Cup, so let them enjoy themselves. Letting them see you laugh is a great way of showing them you're a warm, likeable person. Try 'beat the coach' activities, where you are involved (e.g you try to tag them in a square; you go in goal and they try to score past you; or 'if you score ten goals in three minutes, I'll have to sprint to the halfway line and back', etc.)

Respect every individual!

Children need to feel valued, and this helps them develop self-confidence during this key phase of their social growth.

Give lots of praise!

There's no greater motivator of young players than a large portion of praise. Note that praise is not only given for doing something well; 'great effort', 'good try', 'nice work', etc, can be used to motivate kids too.

Ask questions

Rather than telling kids what to do, get them to think. For example, ask 'Where do you think you could run to make it easier for him to pass the ball to you?' Wait for attention before asking your question, let the child answer, then provide feedback. (Remember, don't keep stopping the game!)

'To tell denies or negates another's intelligence; to ask honours it. Questions generate awareness and also responsibility'

J. Whitmore

What 'tools' do I need?

Encourage after 'mistakes'

Coaches of youngsters should never see the kids' errors or mistakes as negatives: everything that happens is a 'learning experience', and they can learn as much from a miskick or a loss of possession as from a successful shot at goal.

Display excellent social skills

Your behaviour is usually imitated by children, so make sure you're a good role model. Be polite, respectful, and calm under pressure. Communicate with each player individually, and talk regularly to the parents.

Be patient!

Training with younger age-groups can be frustrating at times, so remember 'patience is a virtue.' Don't have unrealistic expectations – expect things to go wrong. Usually, it's not their intent to stop things working, it's just their age!

Note: good planning and organisational skills often prevent many of these frustrations occurring.



What 'tools' do I need?

Organisation Skills

Plan practice sessions in advance

Think about the session and write it down beforehand. Players do not get the most out of training if the coach just makes it up when he arrives. Even the most experienced coaches plan and prepare meticulously for training sessions.

Arrive early and set up your area

A player's time and effort are priceless resources. Don't waste them! You should never leave kids standing around or filling in time while you move cones to set up the next practice area (See "Making best use of your training area" p91).

Give clear instructions

The experienced coach will wait till everyone is listening before giving instructions, which may sometimes require you to call the group in to 'base' or the 'home square.' Then, you should speak in a loud, clear voice accompanied by distinct hand/arm signals. ('All of you in a red bib, stand up, OK, when I give you the signal, all of you move into that square there' etc).

Demonstrate quickly and efficiently

'A picture paints a thousand words', and likewise 'a good demonstration saves a lot of talking.' You don't need to be a great player to do this – just showing the general idea, even in slow motion, is usually enough: 'you run towards this cone, stop the ball here, then run back,' etc. There is also nothing wrong in using one or more players from your group to show the others what they need to do. Try to limit the time spent explaining to around a minute.

Keep the session flowing

Young children have short attention spans, so keep their interest by regularly changing the activity. Build this factor into your session plan.

Vary the type of activity

Changing the environment keeps children motivated. Mix and match from all the possible types of set-up; lines, triangles, squares, grids, static/moving, free space activities, opposed/unopposed, even teams/uneven teams, with ball/without ball, competition/non-competition, etc.

Give everyone a fair go!

A key component of your organization is to ensure that all the children experience all possible roles to an equal extent. Avoid giving players specialised roles, which can also be seen by other players as favouritism.

Note:

Research shows that children drop out of organised sport when:

- there is an over-emphasis on winning
- they don't get enough playing time
- they don't have enough fun
- the coach directs them too much

What are the ingredients of a kids' training session?

The simplest way of looking at a kids' session is to consider it as having, like many things in life, a **beginning**, a **middle** and an **end**.

This book aims to help you take this easy approach to session planning and use it to provide enjoyable and meaningful practice for young players.

The Beginning

1. General Movement

(run, jump, land, stop, start, balance, agility, co-ordination, twist, turn, etc.)

2. Tagging Games

3. Ball Mastery

The Middle

1. Passing and Receiving

2. Dribbling

3. 1v1

The End

1. Shooting games

2. Small-sided games

Advice on putting a session together can be found on page 81.

The Beginning

Warm-Up & Stretching for Young Footballers

The warm-up required for 6-10 year-olds is important but has a different purpose to the warm up for older players. The primary goal of the warm up for older and elite level players is to prepare for competition, prevent injury and improve performance. However for younger players the goals should be more engineered towards organisation, learning and developing better movements.

Over the course of the season, many coaches spend a lot of time on warming- up and stretching. (If each warm up is 10-15minutes, training twice a week plus the game on the weekend, over 30 weeks of pre-season and competition, between 15 & 22 hours is devoted to the warm up.)

However, following the activities in 'The Beginning' section contained in this book will incorporate the components of a sound warm-up, without taking away any of the players' training time.

The primary focus of a warm up is to address three areas;

1. Increasing core temperature
2. Mobility exercises
3. Football-specific exercises

Increasing Core Temperature

As the name would suggest, the goal is to elevate the body temperature, as the body performs better at a higher temperature. The muscles and joints move more fluidly, so fast, power-based movements like sprinting, jumping and kicking are easier to do.

Only a few minutes are required to achieve this with younger players as they will tend to be fairly active from the time they arrive at the training ground until training actually commences.

Older teams will often start the warm up by running around the field. This is not advisable for younger players and may be viewed as a chore. The most important goal is to get younger players moving without making it too structured or turning it into a physical task. Unstructured movements such as jogging, skipping, hopping, bouncing and other basic human movements will help elevate core temperature.

Use the suggested activities in the 'general movement' category in 'The Beginning.' Basic activities like these help provide the basis for most team sport movement.

Doing these types of activities in the form of a game or relays will be advantageous as it engages young players in the activities and makes use of their competitive nature. The 'tagging games' in 'The Beginning' are great for this purpose. The juggling exercises contained in the 'ball mastery' section may be used if there are enough footballs to go around.

The Beginning

Mobility Exercises

Mobility exercises help to increase the range of motion and fluidity of movements in all athletes. They also continue the process of elevating the body temperature. Research has shown that mobility type movements are more effective in the warm up than traditional stretching exercises (which also have their place in 'The Beginning' but will be discussed later).

Mobility exercises involve controlled movement through a particular range of motion. These exercises are done slowly but smoothly. They replicate many movements people already do quite regularly.

Simple movements such as squats, walking lunges, side lunges and knee lifts can be used to improve mobility and increase range of motion. A number of these have been included below.

A smart approach with younger players would be to spread these exercises out across 'The Beginning', as opposed to doing them all at once. For example, the group may do a running activity for 30 seconds, followed by one mobility exercise, then a skipping activity, then another mobility exercise and so on for 4 or 5 series. The advantage for this approach is as little time as possible is spent standing still and the warm up remains active. Younger players are more likely to pay attention than if they spent several minutes sitting down or doing exercises one after the other. See 'sample structures', pages 18/19.

Exercises should be kept short, doing between 5 & 8 repetitions. The coach should take time to assist players to perform mobility exercises correctly. Four or five exercises should be done every session.

Sample Mobility Exercises

1. Squats

- Start with legs a bit wider than shoulder width and arms out in front.
- Keep the weight on the heels, back flat and sit backward slightly on the descent.
- It is important to keep the trunk rigid and keep the head up.
- On the ascent, bring the hips forward.
- It is important to keep the feet flat on the ground and the knees in line with the feet.



The Beginning

2. Split Squat

- Stand with one foot out in front of the other, back straight and hands on hips.
- Lower the back leg until the knee nearly touches the ground. Allow the back heel to move freely.
- Lift straight back up to the starting position, keeping the knee and foot in line.

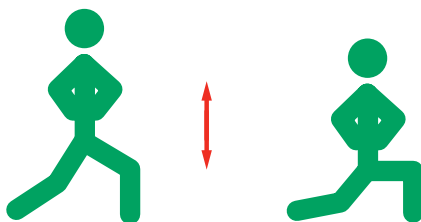

3. Big Steps (Lunge)

- Start with feet together, hands on hips and head up.
- Take a long step forward, dropping the back knee to the ground.
- Try to get back to the starting position in one smooth movement, keeping the knee and foot in alignment.

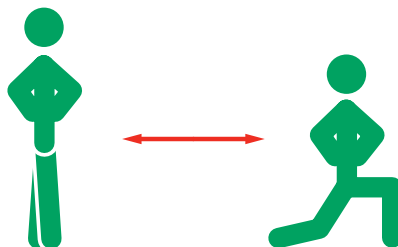

4. Side Lunge

- Start in the same position as the lunge.
- Take a large step to the side, keeping the trailing leg straight, similar to the standing groin stretch position.
- Step back to the starting position in one smooth movement.

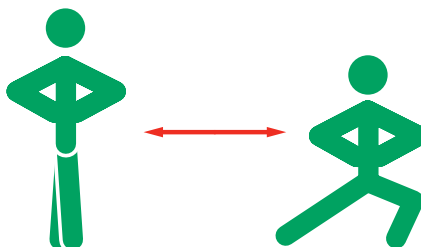

The Beginning

5. Big Steps Forward (Walking Lunge)

- The walking lunge starts the same as the Lunge, with the same movement technique.
- However instead of pushing back to the starting position, the player steps forward, continuing the drill, one step after the other.

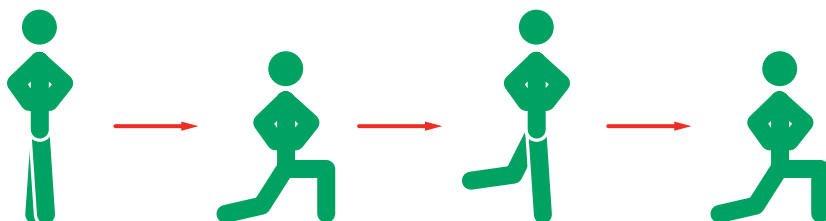

6. Big Step Back (Reverse Lunge)

- This exercise is similar to the lunge, only instead of stepping forward the athlete steps backwards.
- The athlete recovers by stepping forward, back to the starting position.
- The Reverse Lunge is an excellent exercise for developing the hamstrings, a constant problem area for most football players.

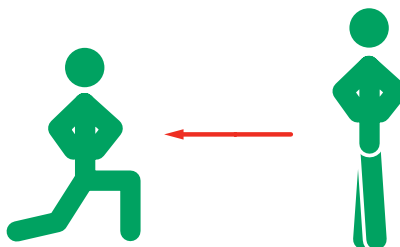

7. 4 Way Lunge

- This exercise combines the lunge with the side lunge and the reverse lunge.
- The player performs a normal lunge, then a side lunge to the left, a backward lunge and a side lunge to the right.
- After each repetition the player comes back to the central starting position.

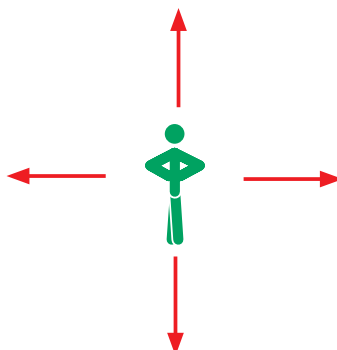

The Beginning

8. Crab Walks

- The player assumes a position for a push up. The feet are approximately 15cm apart and the arms are shoulder width apart.
- Keeping the back as flat as possible, they begin to move to the side. This is done by alternately bringing the hands and feet together and apart.

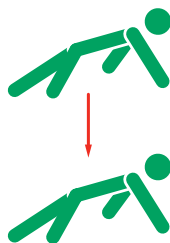

9. Lower Body Twists

- The players lie on the ground on their backs.
- They lift one leg directly in the air up to ninety degrees, then rotate it to the opposite side (left leg is dropped to the right and vice-versa). The leg should be lying on the ground at 90 degrees.
- The legs are reversed and the drill continued.

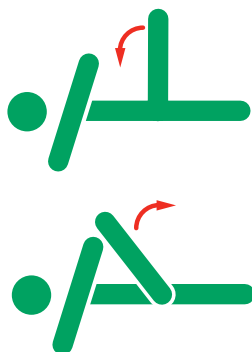

10. Soldier Walk

- The players walk forward, swinging one leg up in front.
- The leg is kept straight, lifting up to 90 degrees.
- The legs are alternated, on every step, coming up on the toes and keeping the back straight.

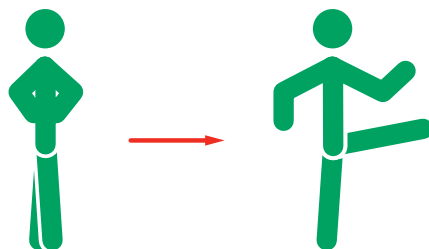

The Beginning

11. Emu Walks

- Players stand on one leg, with hands by the side and the other leg slightly behind the body.
- They lean forward, keeping the body in a straight line and try to touch the ground while balancing on one leg.
- They then return to the starting position, step forward and continue on the other leg.
- The body should always be in a straight line with the trailing leg.

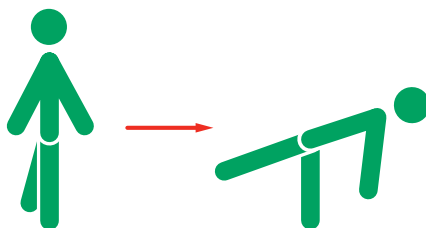

12. Step 'n' Twist

- This exercise uses the same technique as the normal lunge, however the players hold their arms out to the side.
- When the player steps forward, they twist their body in the same direction.
- For example, when the player steps forward with the right leg, the torso is twisted to the right.

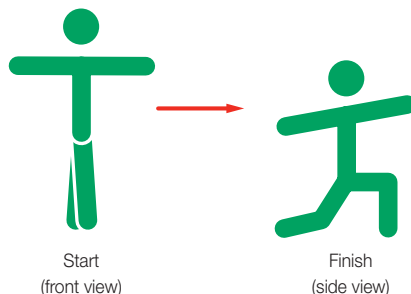

Football Specific Exercises

Once the body temperature has increased and the players have done some general mobility exercises, the warm up should conclude by including some basic football exercises. The risk of injury, in particular the hip and groin region is reduced if a general warm up is done first, and then followed by kicking movements.

Any football skill can be included at this point. It may be in the form of a drill or in the form of a game. With all players, but particularly slightly older ones (aged 9-10) it would be advisable to keep the intensity of the kicking low until the body is fully warmed up.

Stretching

Children tend to be more flexible than adults. They also tend to have much shorter attention spans. Performing a stretching routine during the warm up, even a short routine is therefore probably not the best use of time. Studies have shown that static stretching in the warm up has less benefit than mobility type exercises for preparing the body for training.

However, it would be beneficial to begin to teach young players how to stretch. This will help stretching to become habitual and they will be more likely to stretch correctly as they get older. Therefore, teaching young players some stretches is a very good idea. As they get older, more stretching activities will be required to maintain flexibility. There are several different types of stretching, however simple static stretching is probably best for young players as it is very easy to learn.

The Beginning

Stretching Guidelines

- Perform each stretch slowly, holding at a point where the stretch is felt but is never painful.
- Avoid stretches that involve twisting or turning the joint out of its natural alignment.
- Hold each stretch for 10 seconds (any longer and the players may start to lose focus).
- Do not bounce or move around during the stretch
- Perform one or two stretches at a time towards the end of 'The Beginning', then move onto another activity. This will keep the players moving.

Suggested Stretching Exercises

- Hamstrings
- Quads
- Groin
- Hip flexors
- Adductors

The Beginning

Sample Structure 1 ('The Beginning')

- 60 sec slow running
- 60 sec fast running
- 6 squats
- 60 sec skipping
- 6 lunges
- 60 sec running backwards
- 6 side lunges
- 60 sec running with big strides
- 6 emu walks
- 60 sec 'Line Dancing' (page 24)
- 6 soldier walks
- Hamstring stretch / quad stretch
- 3 mins 'Stick in the Mud' (page 36)
- Groin stretch / adductor stretch

Move on to 'The Middle' part of your session

The Beginning

Sample Structure 2 ('The Beginning')

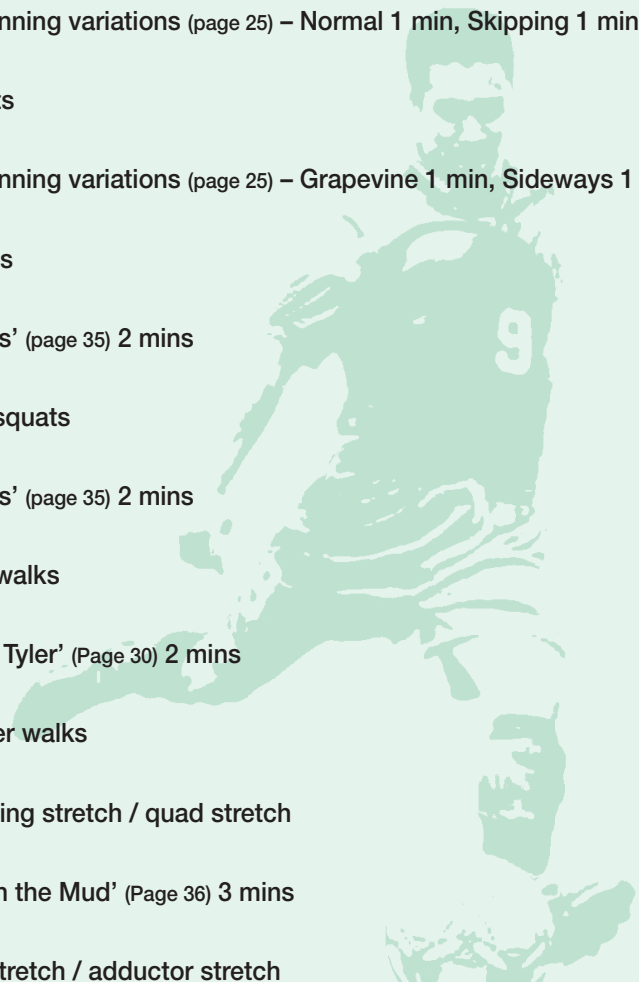
- Line-running variations (page 25) – Normal 1 min, Skipping 1 min
 - 6 squats
 - Line-running variations (page 25) – Grapevine 1 min, Sideways 1 min
 - 6 lunges
 - 'Tunnels' (page 35) 2 mins
 - 6 split squats
 - 'Tunnels' (page 35) 2 mins
 - 6 emu walks
 - 'Martin Tyler' (Page 30) 2 mins
 - 6 soldier walks
 - Hamstring stretch / quad stretch
 - 'Stick in the Mud' (Page 36) 3 mins
 - Groin stretch / adductor stretch
- 

Move on to 'The Middle' part of your session

The Beginning



1. General Movement

2. Tagging Games

3. Ball Mastery



The Beginning

General Movement

At the younger ages, kids need to learn basic athletic movements, and there is growing evidence that this area has become neglected. Research suggests that general motor skills are not being learned well enough before the age of 11.

Football coaches have a responsibility to ensure that young players are provided with opportunities to develop general motor skills. These skills include running, jumping and kicking as well as agility, balance and co-ordination.

There is also evidence that more teenage athletes are experiencing problems with their athletic requirements, and also an increase in injuries, because of limitations that could have been prevented by more appropriate training at an early age.

Kids need to develop control of their bodies, which will give them a better chance of performing more complex skills and movements later on.

A term that is often used to describe this is 'physical literacy'.

Following this principle, coaches will avoid the mistake of 'fast-tracking', i.e. expecting children to be able to perform the difficult, 'adult' actions and skills, before they have even learned to move properly.

Using your imagination, these general movements can be 'fun', and can tap into a child's desire to play, while exploring the boundaries of movement possibilities.

For example:

- run and jump as high as Superman can!
- crawl on the ground like a lizard
- jump up and make a twisted shape with your body in the air, then land and be a statue
- how long can you stand completely still like a flamingo?

The Beginning

'Get Up & Catch'

- Sit on ground, holding ball. Throw it up high, get up quick and catch it before it lands.
- Progression - sit on ground, holding ball. Throw it up high, jump up and kick it (or head it) before it lands. Bonus point if you then catch it.

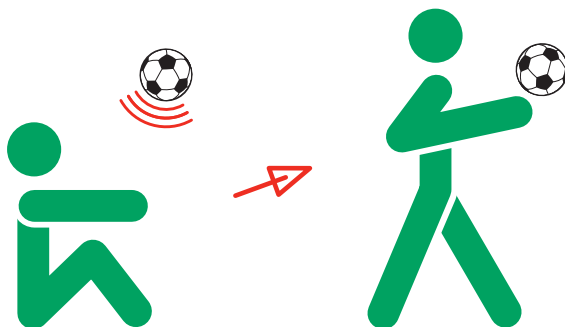

'Spelling Test'

- Each player has a small square (can also be done in free space with an eye out for collisions), and traces out letters by running around her square. 'Imagine you have white paint on the soles of your shoes – write the letters using your feet.' Progress from letters to words, e.g 'spell your name'.

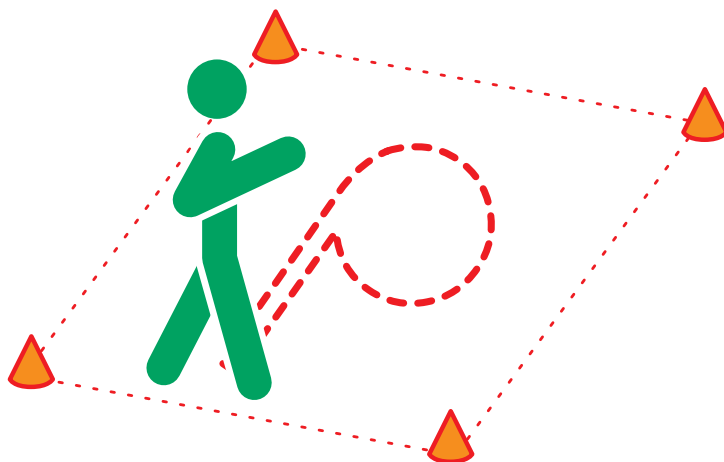

The Beginning

Various Jumps

- 'Squat down low ... jump as high as you can!', 'run to the line and jump as far as you can!', 'kangaroo jump over those three cones', etc.

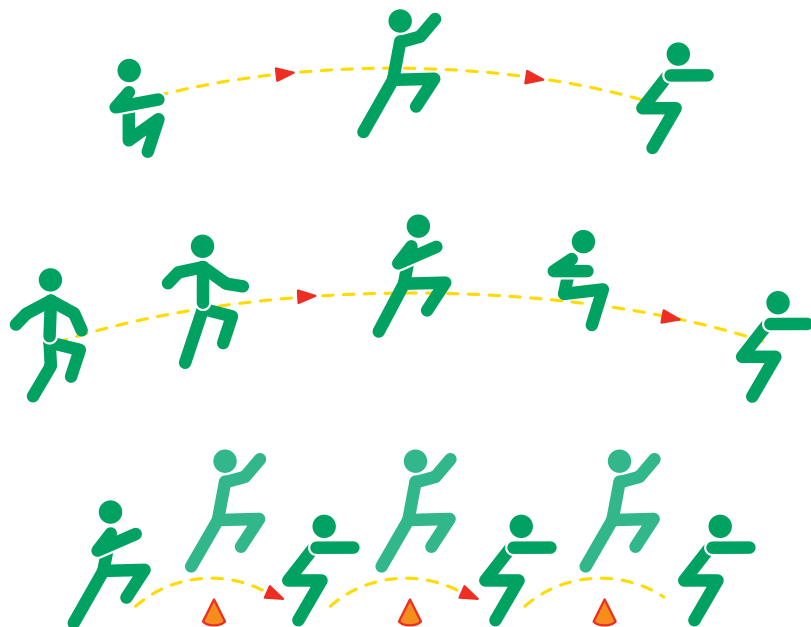

'Forward Rolls'

- Can add jump after roll.



The Beginning

Agility Running



'Line Dancing'

- Players stand in a grid formation, e.g 2 rows of 4, equally-spaced. Coach calls out various movement commands, and players have to follow the instructions while staying in formation ('jog on the spot, jump high, jog on the spot, jog forwards, turn to your left, stop, run backwards, stop, jog on the spot, jump high, touch the ground, jog forwards, turn right, turn left, run backwards, etc.')

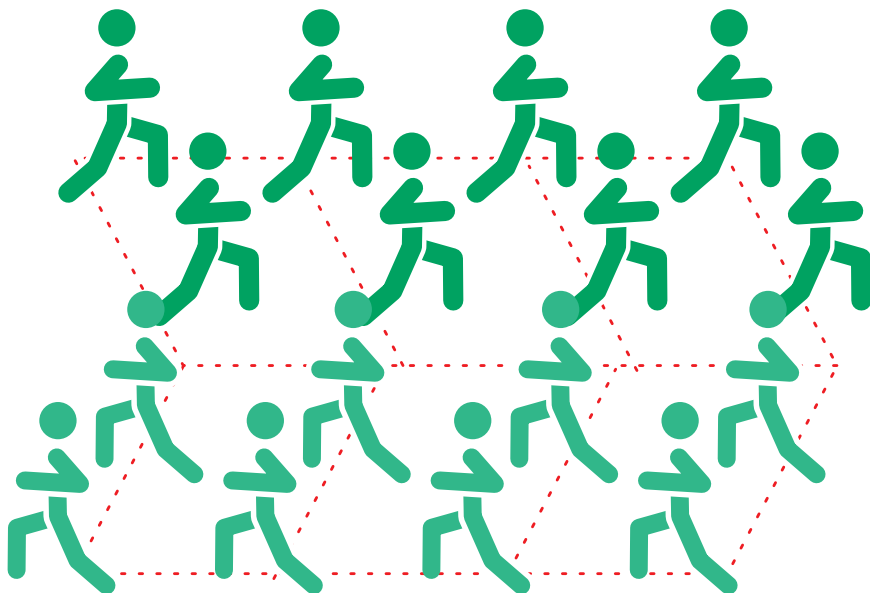

The Beginning

Line Running Variations

- Short steps, long steps, straight leg running, 2-footed jumps (kangaroo), heels to your bottom, knees up high, sideways, grapevine, backwards, shuffle side-to-side, etc.

Accelerate/decelerate

- Free running exercises involving changes of speed (increase/decrease) in a straight line.

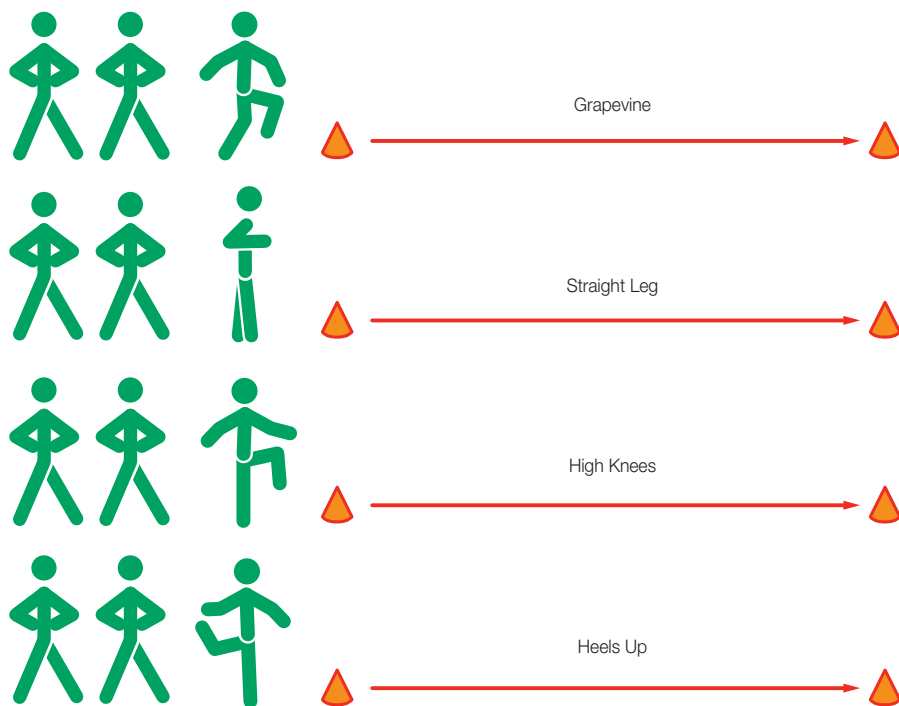

The Beginning

Various Balance and Flexibility Exercises

Seated, move ball around trunk



Seated, legs apart, touch alternate feet with ball



Balance on one leg, move ball around trunk



Balance on one leg, move ball around other leg



Balance with one hand on ball



Balance in push up position, both hands on ball



Move feet forward slowly, keeping hands on ball



When feet are far enough forward, raise yourself to a standing position, ball in hands



The Beginning

Relays

Great way to get players warm and motivated (with younger kids, it is often better to do these without the ball).

- **ONE LINE** - Simple variations on 'run to far cone, run around it, come back and touch the next player's hand.



- **TWO LINES** - Variations on 'run to other end, touch the next player's hand, then he runs back to this end, and so on.'



VARIATIONS WITH BALL

A) Dribble around cones

B) Advanced - ball goes inside cones, you go around cones

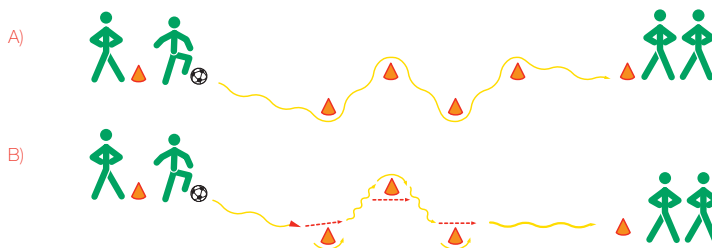

- **MORE ADVANCED** - Leave ball at first cone, run to far ball, perform skills (e.g. 10 juggles, 10 sole taps, etc.) then run back to other ball and pass it to next player.

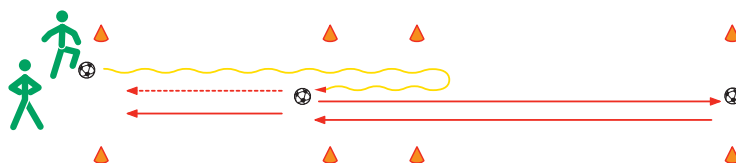

The Beginning

- **ACTION SQUARE** – Mark a square halfway along the length of the relay; as they enter that square, they perform a prescribed action (touch the ball 10 times on the ground using both feet; dribble ball from near end of square to far end and back and continue running; etc)

Action Square

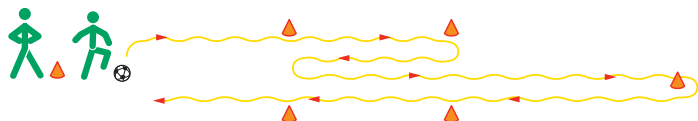

Simpler variation

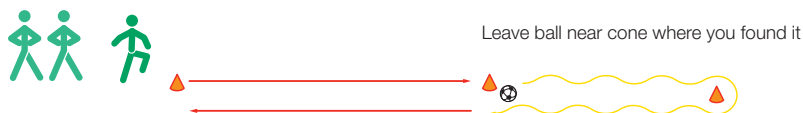

- **FETCH AND CARRY** – Various methods, e.g. leave a ball on the far line, 1st runner goes and picks it up, carries it back to next runner who runs and puts it back on the line.

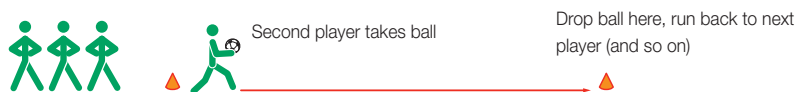
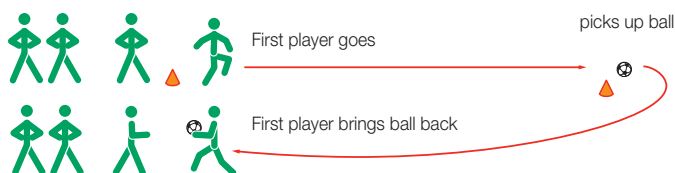

Variation



Each player runs through gate then picks up one item (bib, cone, etc) and runs back with it through the gate. When she reaches the start line, the next player runs, (and so on until all items are collected).

The Beginning

- **OBSTACLE COURSE** – Set up a 'course' that is not in a straight line, and a second one in a mirror image of that one, e.g. run to first cone, turn left, weave in and out of cones, turn left at next cone, jump over the four bibs, run to far cone, turn left and touch next player's hand (other group do reverse, i.e 'turn right').

Can also be a race or a relay

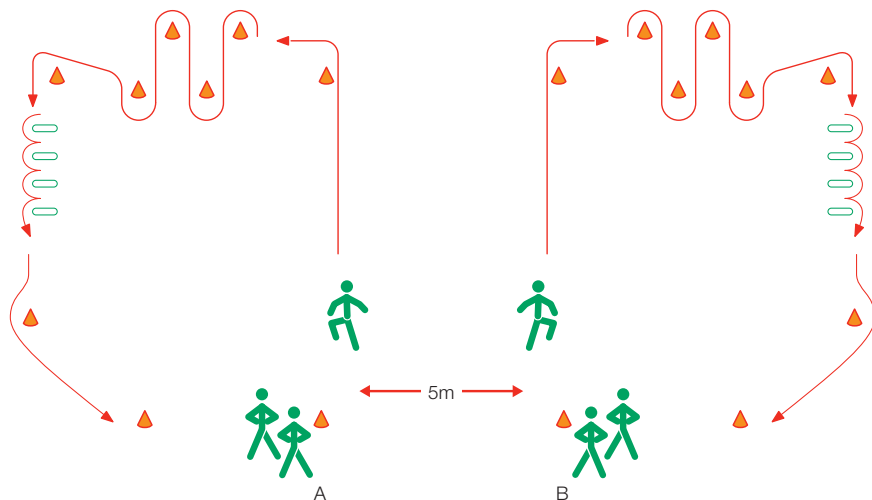

Bibs/cones to run around, jump over, etc. (can add ball to make it a dribbling course)

The Beginning

Imagination games:

- a) **'Martin Tyler'** – A great fun activity that taps into the players', and your own, imagination, while getting them warm and motivated. As the name suggests, the coach takes on the role of a match commentator (Martin Tyler is widely regarded as the world's best). Gather the players into a group with adequate spaces between them. Tell them they're about to play in the most important game of their lives, perhaps the World Cup Final. There is an imaginary ball at their feet. Then, you commentate and they act it out. For example: 'OK, you're dribbling the ball, great skills from the youngster, it's his first game for Australia, dribbles past one defender, and another, now he sprints forward – OFF YOU GO! SPRINT! – he slows down, AND SHOOTS! Great shot, GOOOOOOAL! – celebration (belly slides, etc!) – Now, France are breaking away with the ball, let's chase him, RUN! - and the youngster tackles him (slide tackle) – the ball flies up in the air – jump up and head it – great header! – the ball falls to Zidane, who shoots, you're the goalkeeper, it's going into the top corner, CAN YOU SAVE IT? – dive to your left NOW! – GREAT SAVE! You've got the ball in your hands, kick it as far as you can, and the youngster is chasing it, he's running with the ball, RUN! he dribbles round the keeper and HE SCORES! The crowd goes wild here in Telstra stadium, it's 2-0, AND THE WHISTLE GOES, it's all over Australia have defeated France 2-0, and Australia are the World Champions – celebrations, shake hands, team photograph!' Use your own imagination to come up with a scenario they will enjoy; try to incorporate running, jumping, diving, dribbling and lots of fun, including GOALS!
- b) **'Magic Ball'** – 'you've got a magic, invisible ball in your hands – throw it up and kick it to Melbourne; now let's kick it to what team does Harry Kewell play for? (kids answer – 'OK, let's kick it to Liverpool!'); 'now, balance the magic ball on your head – don't let it fall off – now, balance on one leg... don't let it drop – now, balance on the other leg – flick the ball off your head and catch it on your foot – keep it there – now hop on your other foot, without dropping the ball, etc'

The above games are great for introducing a fun atmosphere, while allowing kids to experience imaginative play. Just as importantly, they can be used to incorporate most, if not all, of the 'physical literacy' aspects of general movement (run, jump, land, balance, agility, accelerate, slow down, twist, turn, etc.). More creative coaches might use an imagination game scenario for the whole of 'The Beginning' section: stretching and mobility exercises can be added in various ways.

The Beginning

'Me and My Shadow'

- In pairs, follow your partner as she jogs and changes direction all over the training area.



'Throw and Move'

- 8 players in a square, 4 balls; players throw the ball to a player who doesn't have a ball, then move to see where they might receive the next ball from. Good for developing communication too, as players should start to call for the ball, or call the player they are looking to pass to. **Variations:** Throw ball high for next player to jump and catch; players hand ball over to next player while on the move ('crossover').
- **Variation:** as above, but passing with the feet, instead of the hands.

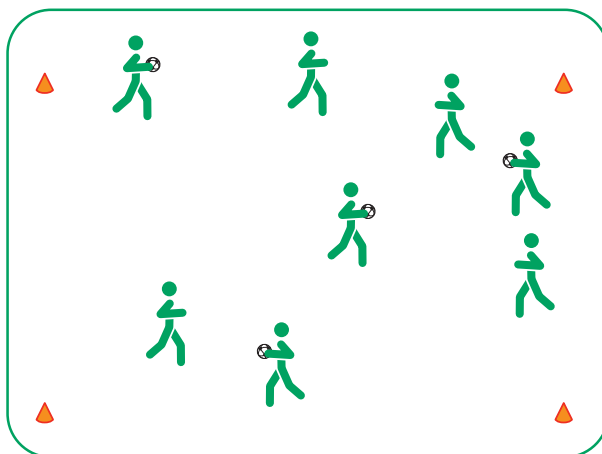

The Beginning

'Vietnamese Bib Tag'

- 3 players link up, arms round shoulders. The middle player has a bib tucked in the back of his shorts. Fourth player has to try to get round the back and remove the bib, while the three linked players move around to prevent him.

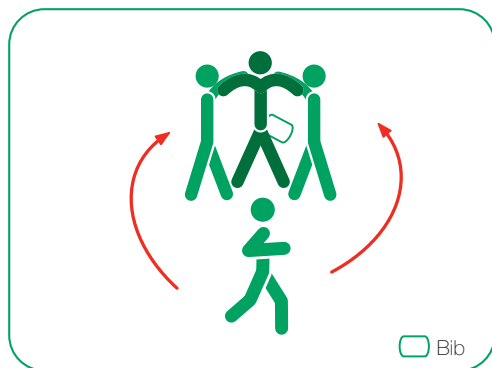

'Feather The Nest'

- 10-12m square, team of players positioned at each corner, cluster of balls in middle. Object is to gather as many balls as possible for your corner ('nest'); one player from each team goes to get a ball from the middle and place it near his corner, then the next player from his team goes to do same; when balls in middle are all gone, you can take them from someone else's 'nest'; IMPORTANT: You cannot stop people taking balls from your corner – no blocking, defending, tackling, etc.

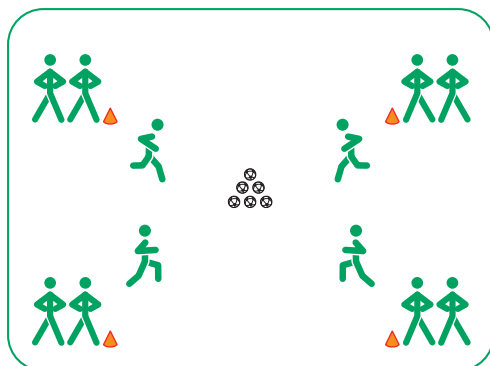

The Beginning

'Robin Hood'

- 2 teams of 6, split up as below; each team starts with 5 balls in their 'safe.' When the game starts, each team can start stealing balls from the opponents' safe – there is 1 'thief' who takes a ball and throws it across the first 'moat' to one of his team mates, who then throws it across the second moat, who in turn throws it to his team's 'collector' who puts it in his team's safe. Meanwhile, your opponents are doing the same with your balls! After set time period (e.g. 2 minutes), which team has the most balls in their 'safe'?
- **Progression:** You can't use your hands – feet only!

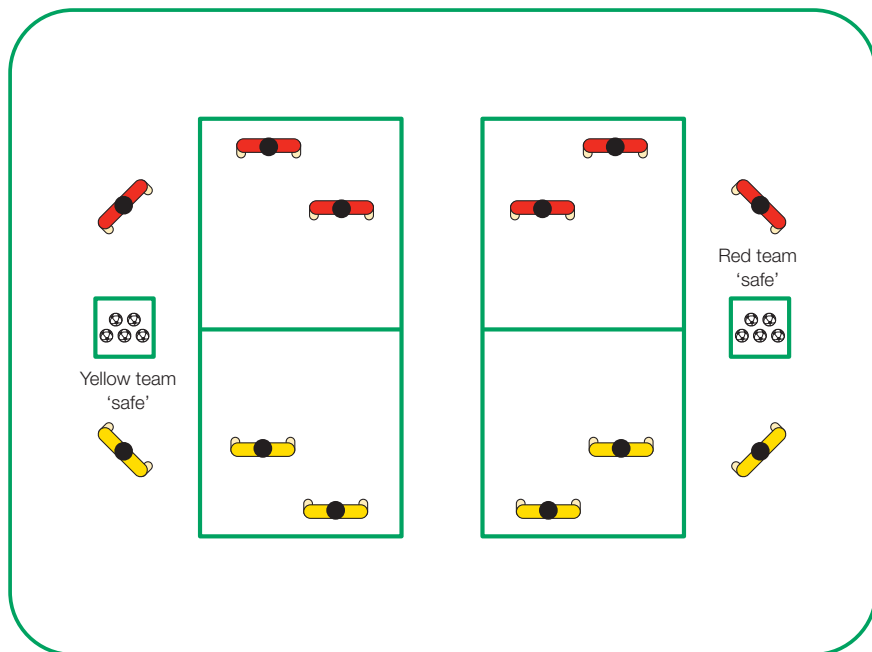

The Beginning

'Empty it! Fill it!'

- Players in 2 teams dribble balls (or bounce them, etc) around a square. Outside the square, each team has 2 boxes marked out, one for their balls, one for themselves. On the call, 'empty it!', they compete to be the first team to empty the square appropriately. 'Fill it!', means which team will be first to get all their balls and themselves back in the square.

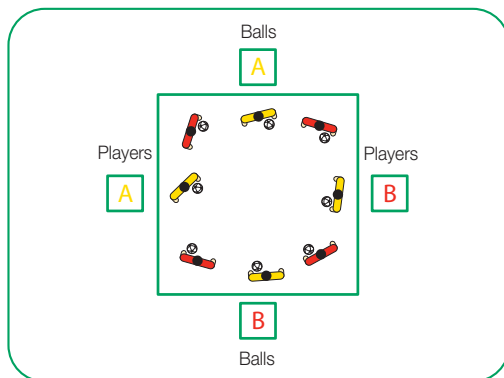

Tunnel Ball

- The old favourite.

'Crab Pot'

- In a square, players dribble their balls trying to avoid the 'crabs' who move around on hands and feet (chest facing upwards); if a 'crab' kicks your ball out of the square, swap with the 'crab' responsible. Circa 6m square.

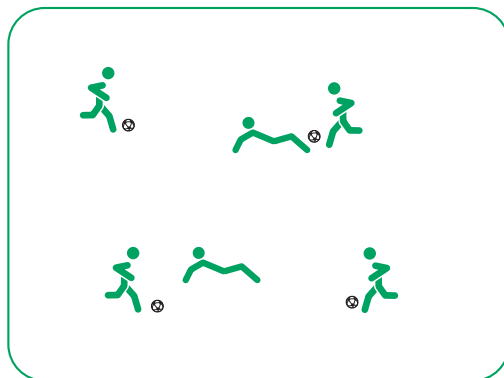

The Beginning

'Tunnels'

- Half of group stand still, legs apart. How many tunnels can you get through in 20 - 30 seconds. Then change.

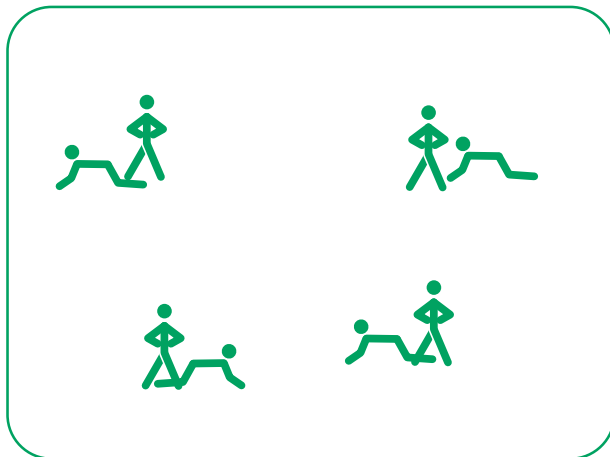

'Bridges'

- Half of group in prone brace position; other half jump over their WAISTS. How many jumps in 20 seconds?

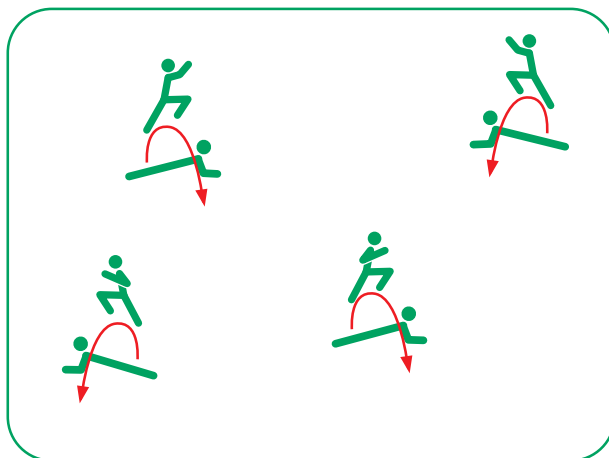

The Beginning

Tagging Games

Games that involve chasing and dodging are great exercises for players young and old for a number of reasons:

They

- are fun
- are motivating
- are competitive
- get players warm
- involve changes of speed
- involve changes of direction
- develop the key skill of 'faking' (i.e. make someone think you're going to move in one direction, then accelerate in the other direction), which complements the development of 1v1 skills
- satisfy many of the 'physical literacy' components (see 'General Movement')
- help develop vision and decision-making
- can involve teamwork

Sometimes, a tagging game can replace the '**General Movement**' component of a training session.

- '**CATCH THE TAILS**' – bibs tucked into shorts can function as 'tails'; a hunter (or more than one) chases the others, trying to remove their 'tails.' If your tail is taken, you become a 'hunter.'
- '**PAIRS TAG**' – A pair of 'hunters', who are joined by holding hands, chase solo runners, who when tagged join together with the 'hunters' to make a three, and so on till everyone is tagged.

'**STICK IN THE MUD**' – 15m square approx, 6 players try to avoid 2 players who carry balls in their hands; ball-carriers attempt to tag the runners by touching them with the ball (make sure ball is not thrown, and that players aim for the trunk); if you are tagged, you 'stick in the mud' with your legs wide apart, until a team-mate frees you by crawling through your legs. 30 seconds each pair, then change.

The Beginning

'Dog and Bone'

- In a 10m square, the 'bone' runs in from one corner, and has to run across either of the two sidelines opposite. The 'dog' waits halfway across square and has to get the 'bone' by tagging her before she crosses one of the lines.

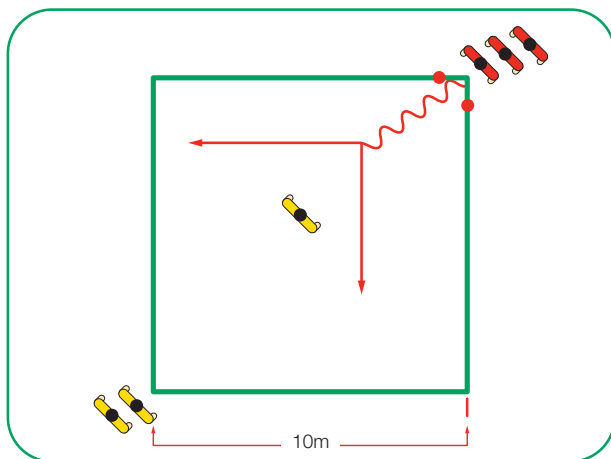

'React and Sprint'

- Make two adjacent narrow lanes, c. 2m wide and 12-15m long. A player stands in the middle of each lane, facing his opponent. The endlines at one end are marked with cones of one colour, and those at the other end with cones of a different colour. Players wait (or jump on the spot) till the coach calls out a colour, then it's a race to the end where the cones of that colour are.

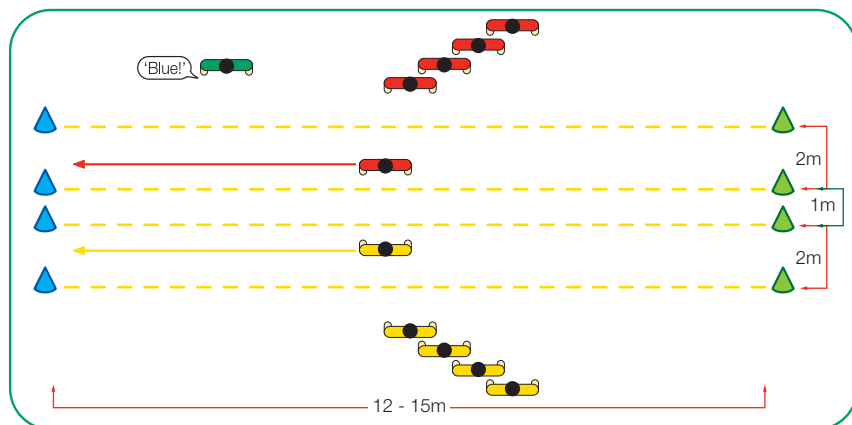

The Beginning

'Beat Your Reflection'

- Same set-up as 'REACT AND SPRINT'. A player stands in the middle of each lane, facing his opponent; one is 'real' the other is 'the reflection.' At any time, the 'real' one can set off to either end of his lane and has to cross the endline before the 'reflection' crosses his. The 'real' one should use feints and changes of direction – the 'reflection' tries to react accordingly. Change roles regularly; keep score.

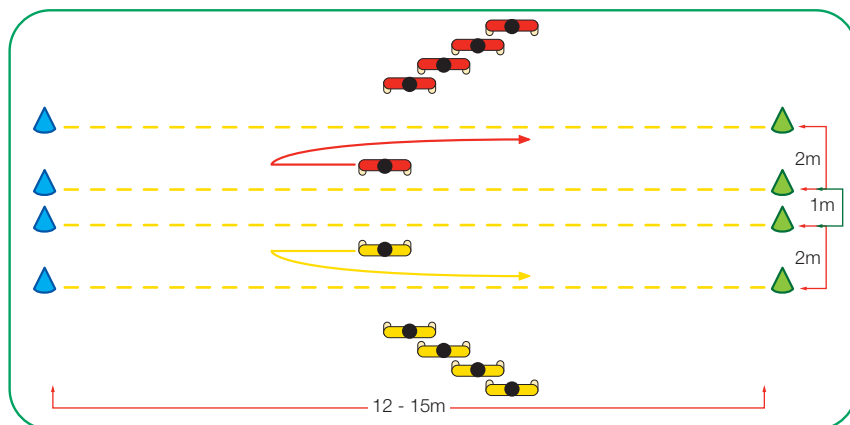

Other Games

Variations on other sports such as netball and basketball can help develop game awareness.

Concepts such as 'creating space' and 'invading someone else's territory' are easily learnt, since the players are using their hands.

Some aspects of creative attacking play (give and go, takeover, interchange of position, etc) can be introduced more easily using games where players can hold and throw the ball with their hands.

Using these games from time-to-time can also add another element of fun and variation to sessions.

Example:

- Netball – adapted version of netball; you can't run with the ball, throw and pass amongst your team to keep possession in a grid, 10 passes equals a goal, no contact, cannot get closer than 1m to the player with the ball.

Progression; Score a goal by passing to one of your team who has run into the 'end zone', or a 'target player' from your team who stays in the end zone (rotate target players regularly).

The Beginning

Ball Mastery

Mastery of the ball is arguably the most important aspect of a player's development. Grassroots coaches have a crucial role to play in assisting this development.

Learning to master the ball takes many years, but the foundation for future skill development is laid in these early years.

By including juggling-type exercises and ball feeling exercises in 'the beginning', coaches are ensuring that players experience a lot more touches of the ball and get to 'know' their ball. As this progresses, they will hopefully grow to 'love' their ball.

Suggest that they continue to practice the exercises for 'homework'; see if they can come to the next session and show you something else they've learnt to do with their ball ('Look, coach, I can catch the ball on my foot while balancing on the other foot!')

Further aspects of ball mastery, such as passing/receiving and shooting, are included in 'the middle' and 'the end'.

Older, more talented players may be ready for advanced technique training, which is covered on the next levels of FFA Community Coaching Courses and in greater depth on the Advanced 'C' Certificate course.

'Technique can be learned; it necessitates the application of methodological and educational processes and principles.'

'FIFA Coaching'

The Beginning

Juggling Variations

- While standing, hold ball – drop it, or throw it up; let it bounce on the ground, kick it up and catch it. How many can you do in a row?

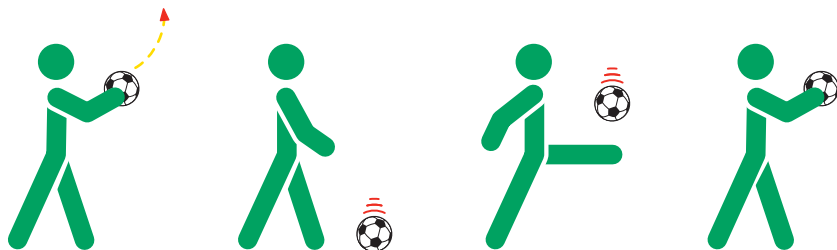

- Now try kicking it up BEFORE it bounces.



- **Progressions of above:** left foot, right foot, then catch it; kick it, then use your thigh, then catch it; left thigh, right thigh, catch; foot, thigh, head, catch.

The Beginning

- Kick it up, let it bounce, kick it up again, let it bounce, kick it up again, etc. – how many can you do in a row?
- Throw it up, head it up, catch it (older players).

Progressions: More than one head touch before catching it; throw it up, head it to your partner, who catches it, then she does the same back to you.

- Head juggling in pairs / Head juggling in threes.
- Heading variations.

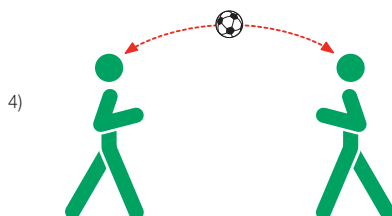
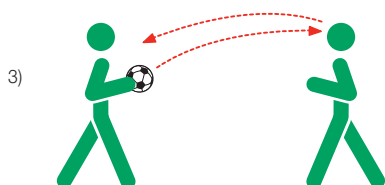
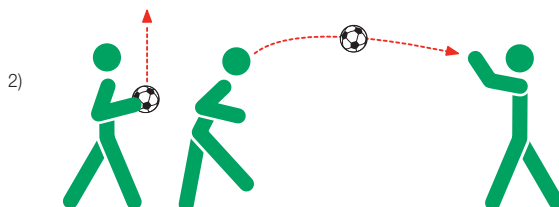
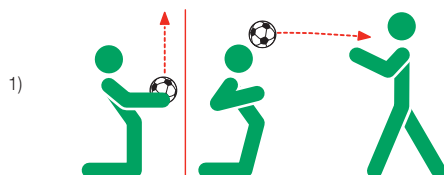

The Beginning

- Partner throws it to you and calls how many juggles you must perform before you catch it (2, 3 or 4). If necessary, allow a bounce between the touches.
- Free juggling – use any legal part of the body to keep the ball in the air (if necessary, allow bounces).



- **Progressions:**
 - Allow one bounce
 - No Bounce
 - Certain body parts (e.g. feet only; alternate feet; thighs only; etc)
 - Improve your score!
(Great for homework)
- Alternate feet juggling – progress to walking while doing so.
- One foot juggling:
 - a) keeping other foot on ground (improve balance)
 - b) keep stepping as you do it (touch, step, step, touch, step, step, touch, and so on) for more advanced players
- Alternate thigh juggling – then do so while walking.
- Partner throws it to you, kick it back for her to catch. (inside of foot, or laces part of foot)

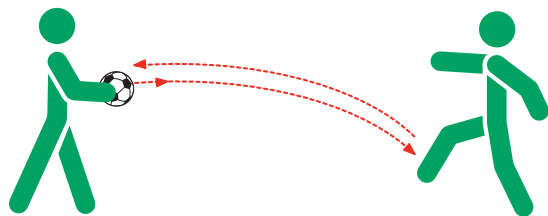

The Beginning

Ball Feeling

- Roll ball around your foot without losing contact with it (sole, inside of foot, outside of foot, heel).
- Drag it back with the sole, push it away with your laces.
- Touch the top of a static ball with the sole, alternate feet. **Progression:** Move ball forward across your square as you do so.
- 'Ground juggling' – move the ball quickly side to side from left to right, touching it with one foot then the other. Use the upper part of the inside of the foot, near the big toe. **Progression:** Move ball forward across your square as you do so.
- Backheels (including 'strike it with heel' and 'roll it with sole.')
- 1 Ball each, backheel towards far line, turn and gather, do same back to start line.
- **Progression:** 1st player dribbles ball away from line, then while still moving, backheels ball to next player in his line.



1. Passing and Receiving

2. Dribbling

3. 1v1



The Middle

Passing and Receiving

'The pass is the very essence of the game on the pitch and of communication between players'

'FIFA Coaching'

Passing and receiving the ball are the most basic requirements a young player needs to function in a game of football.

The concept of 'passing the ball' needs to be developed, so young players learn that passing to team-mates is the basic method of progressing forward in order to score in the opponents' goal. 'Pass and move' is still a cornerstone of football even at the elite level, and therefore encouraging your players to make a run after passing the ball is a sound philosophy.

It is also sound advice to suggest to kids that when they have a scoring opportunity, they would be well-served to 'pass' the ball into the goal.

Observation shows that too many youngsters just kick the ball away when it comes to them. Although there is a place for first-time passing, it is better to instil in kids the notion of 'receive the ball first'. They can then look for a pass or, as their dribbling and 1v1 skills develop, they can decide to run with the ball or beat an opponent with the ball.

'Through The Gate'

- A - 8m square approx, 2 cones in middle as gate, player each end, 1 ball, score point each time you pass ball through gate to team-mate. (Later - how many consecutive passes through the gate can your pair make without hitting the cones?)
- B - **Progression:** 3 or so pairs working, 1 spare player in the middle tries to stop balls going through gates (introduces vision and timing as well as accuracy = 'limited pressure')

A

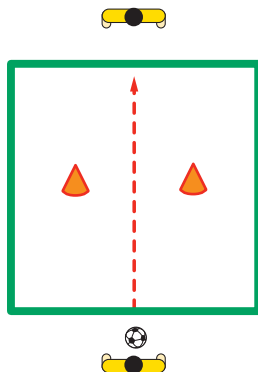

B - Progression

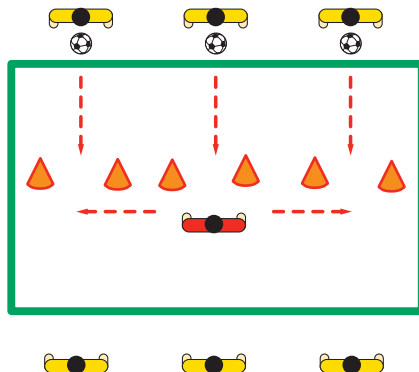

The Middle

'Pairs Through The Gates'

- Set up about 6 small gates in a large square. A pair of players run out with a ball and pass through gates to each other until they have performed 6 successful passes through 6 different gates – 1 pair at a time, beat the clock.
Or, set up 2 identical areas, with 4 gates in each. A pair of players in each area compete to see which pair completes a successful pass through each gate and gets back to start line first.

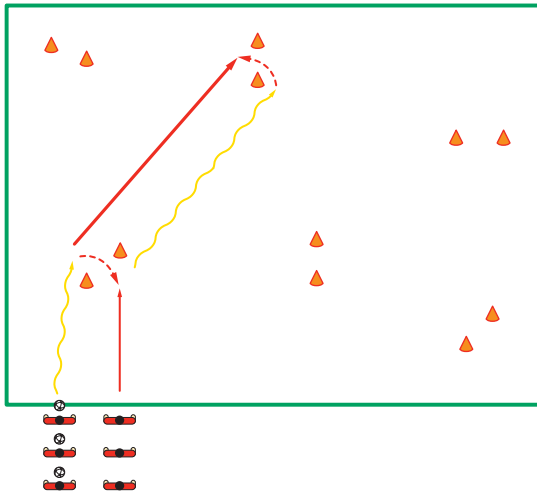

or

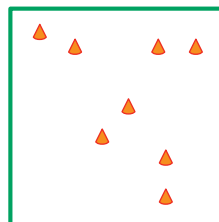
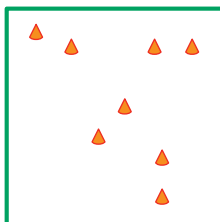

The Middle

Pass & Follow Square

- Minimum of 5 players, pass the ball to player on next corner, then run to his spot. When you receive the ball, stop it, turn to face next corner and repeat. **Later** – introduce concept of 'far foot.' i.e. receive ball with foot furthest from the player who passed it to you.

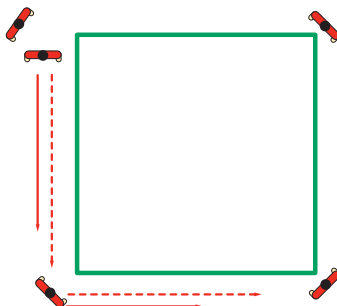

'Tunnel' Target Practice

- **Variation:** tunnel player can move 1 foot (to make it easier)
- Change tunnel player regularly

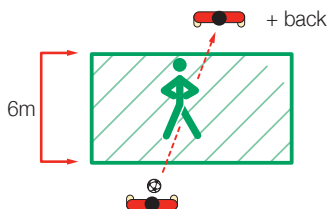

'Tenpin Bowling'

- 2 players 15-20m apart, each has 4 traffic cones on their line, take turns aiming at opponent's skittles, first one to knock all down wins, start again; change opponents regularly. Cones circa 15m apart.

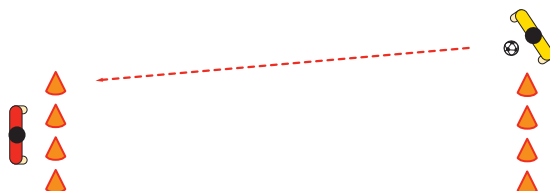

The Middle

'Numbers Game'

- 2 grids approx 8x15m each, marked adjacent to each other. 4 players in one grid, 4 players of another colour in other grid. Each group is numbered 1-4. Players pass in order, i.e. 1 to 2, 2 to 3, 3 to 4, 4 to 1, etc.

Pass ball in number sequence.

Increase challenge by asking players to keep moving around square.

Helps develop vision and communication.

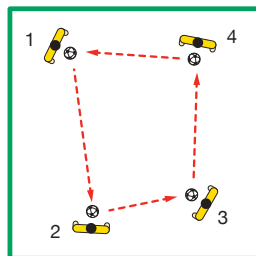
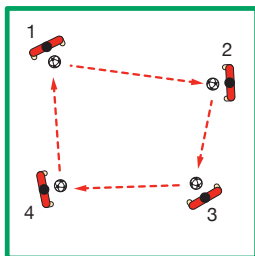

- **Progression:** Take middle line out, players now mingle in large grid, continue to pass in order, but now need to be aware of other ball and other players. Players keep moving around square, passing in sequence with their team.

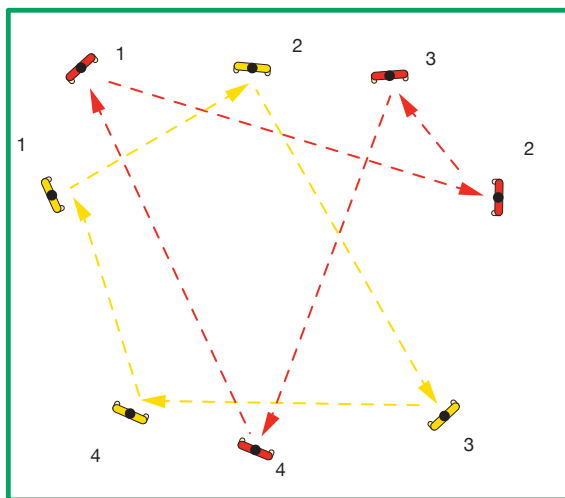

If your players just do what you tell them to do, they are all limited by the knowledge of one mind; imagine the possibilities when you unleash the imagination and personality of all your players.

The Middle

'Shooting Gallery'

- 2 pairs of players (or more) on opposite sides of square. As A1 passes to A2, B1 tries to hit that ball with her own by passing towards B2 and timing it to hit the other ball.

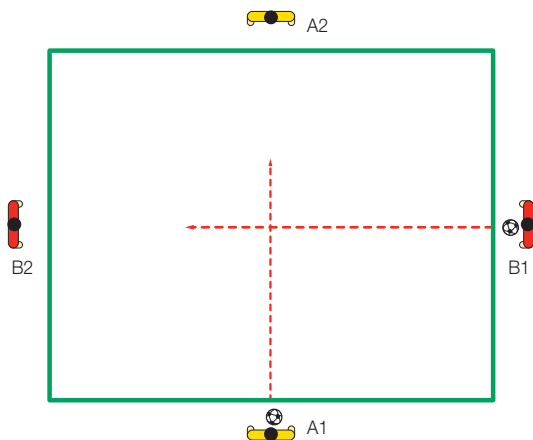

'Formula 1'

- Passing accuracy competition. Set up a narrow lane, or 'track', 1m or 2m wide, with cones spaced at 2m intervals. Players take turns at kicking their ball from the 'start line' down the track, attempting to get it all the way to the 'finish line' without touching any of the side markers. (**Variations:** Longer track; narrower track) Make the track 10m long marked in 2m increments, score 10 points for reaching finish line, or 2 points for each 2m line successfully negotiated.

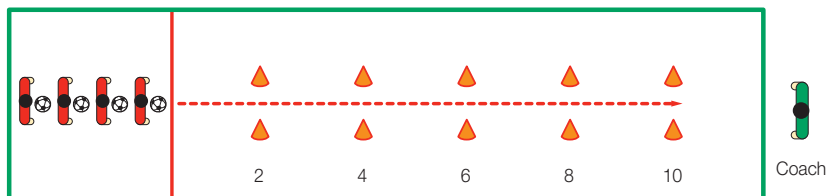

The Middle

'Pass to the Coach'

- A short line of players take turns at passing the ball to the coach, (who is thus able to give feedback to every player) then run to the back of the line. First, 'stop it then kick it'; progress to 'kick it first time (without stopping it first)'.

Variations: After passing to coach, players run to cone on signal ('left', 'right', etc); or set up a different activity each side (weave through closely-placed cones on one side, jump over the bibs on the other side).



3 v 1 in Square

- Three red players keep possession of the ball by passing and moving around the square, while the yellow player tries to win the ball.

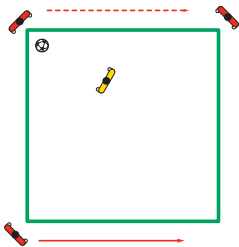
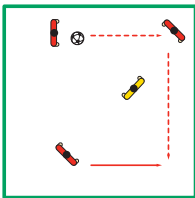

Variation:

- red players must stay outside square and pass/receive at corners
- player with ball must have team mate on his left and right
- change defender regularly

The Middle

4 v 1 Across Square

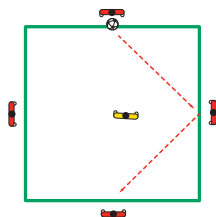

- red players must stay outside the square, yellow player stays in
- red players try to pass the ball to each other while the yellow player tries to intercept
- vary size of square
- increase number of defenders

4 v 2 in Rectangular Grid

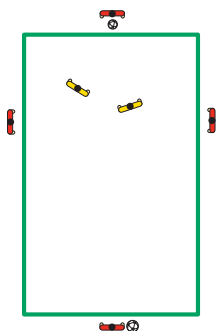

- 20 x 10m (approx)
- red players stay outside
- yellow players stay inside
- red players keep possession, trying to pass ball from one end of the grid to the other, 1 point each time they do.
- yellow stay in till they get 3 points (Score points by: intercept; red comes into square; pass goes astray)
- change yellow regularly

Variation: 4 v 2 in Free Space

- As the players and the ball move, team mates move to keep the original shape
- Player with ball should have one team-mate on left, and one on right

The Middle

'5 v 2' – in a Square.

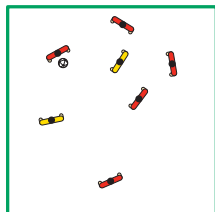

- 5 Red players keep possession, while the yellow players try to win it or force a bad pass out of the square.

Use Often

- Games like this are great for developing passing and receiving, while teaching players about support play. Attackers should try to take up positions where they can receive the ball without a defender blocking the pass. As attackers outnumber the defenders, this is made easier to do.

'3 v 3' with Target Players

- (Advanced) approx. 25 x 15m, 3v3 inside grid, one player from each team at each end, score by passing the ball to one of the end players.

Variation: player on the end has to pass ball straight back to the same team that played it to him - then, that team has to try to get the ball to the opposite end player for another point.

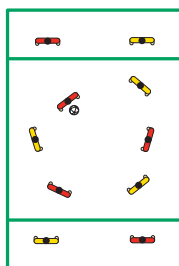

- try to pass to your own end players and get it back = 1 point. Then to the other end
- 2-touch (later 1 touch) in end zone
- **Progression:** when you pass to end player, she brings it in, you swap places

'It is necessary to begin at the beginning. The beginning, in football, is to give youngsters the means to master the ball. Mastery is technique.'

Gerard Houllier - World-renowned French coach

The Middle

'2 + 4 v 2'

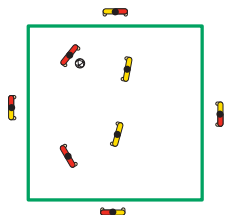

- 2 touch on outside (progress to 1 touch)
- players on outside play for whichever team passes the ball to them
- = 6 v 2

'2 + 2 v 2'

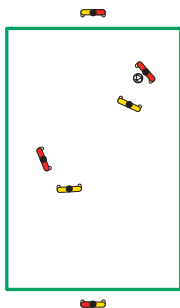

- 2 players on the outside play for which ever team passes the ball to them
- 2 touch on outside; later 1 touch
- = 4 v 2

The Middle

Progression '4 + 4 v 4'

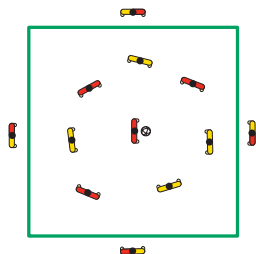

- = 8 v 4
- Players on outside play for whichever team passes the ball to them
- 1 x joker (blue) plays for whichever team has the ball
- 2 touches on one side; later 1 touch

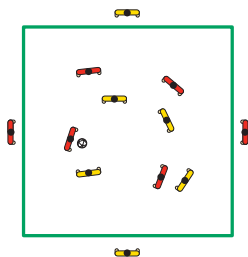

Variation:

- can only use your own colour on the outside
- 6 v 4
- moving forward from back to front as in the real game (i.e. when you receive the ball back from an outside player, head towards opposite end where your other side player is)

'1 Joker Game'

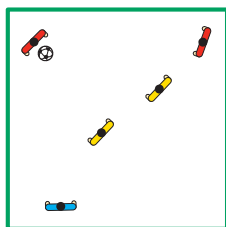

- 2 x red players
- 2 x yellow players
- 1 x joker (blue) plays for whichever team has the ball
- always 3 v 2
- count successful passes, change joker player regularly (need 3 bib colours)
- **Many variations in numbers possible**

The Middle

'2 Joker Game'

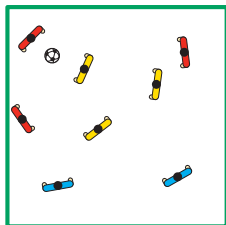

- 3 x red players
- 3 x yellow players
- 2 x jokers (blue) play for whichever team has the ball
- always 5 v 3
- count successful passes, change joker players regularly (need 3 bib colours)

'3 Joker Game'

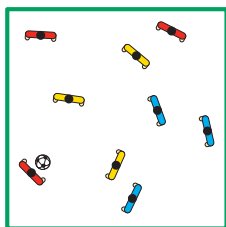

- 3 x red players
- 3 x yellow players
- 3 x jokers (blue) play for whichever team has the ball. Always 6 v 3
- count successful passes change joker players regularly (need 3 bib colours)

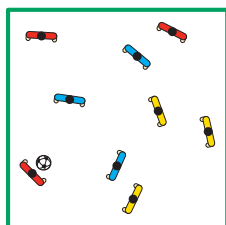

3 Team Game (Variation on Joker theme):

- 3 teams of three (or any number), 1 team is named as first group of defenders. The other 2 teams must keep the ball away from them, (i.e. 6 v 3).
- As soon as defending team wins it, they are replaced by the colour who lost it / touched it last / kicked it out, etc.
- Good for concentration, decision making, transition from attack to defence and vice-versa.

The Middle

Dribbling

Running with the ball is often neglected by coaches of young players. This is evident when watching junior games. Too often, kids simply kick the ball away when it comes to them. Part of the problem may be a lack of practice in this particular aspect of the game, but more worryingly it may be because coaches (and/or parents) are afraid of their team 'losing' the ball.

Players will not develop skill or confidence if they are instructed to just kick the ball towards the other end whenever they get it. Running with the ball should be encouraged as an option after they control the ball.

Coaches need to provide opportunities for kids to practice this so that they learn the right 'touch' of the ball to allow them to run at the desired speed without tripping over the ball and to keep their heads up while doing so. The more they do it at training, the more it transfers to the game.

A distinction between 'dribbling' and '1v1 skills' has been made in this book for simplicity's sake. There are some overlaps between the two, but if coaches view 'dribbling' as 'running with the ball' and '1v1 skills' as 'losing an opponent', the distinction is clearer.

'Criss-cross'

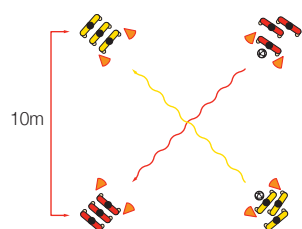

- keep your head up at far end, pass ball to next player

Progression: 4 balls, 4 players

Progression: put cone in middle dribble to 1/2 way and pass through far gate

'North and South'

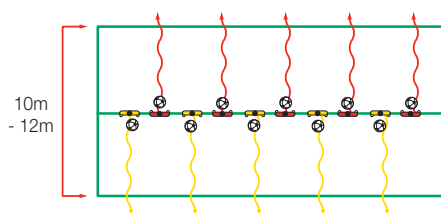

- One team heads north, the other team heads south
- 1. without ball first
- 2. with ball

Progress to:

- race to end lines
- race to end line and then back to start position

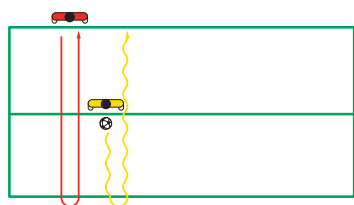

Variation:

- Yellow has ball, red has no ball
- Yellow has head start, vary distance to make it a closer contest, or make it harder for chaser, (e.g. red starts seated on ground)

The Middle

'1-2 Races'

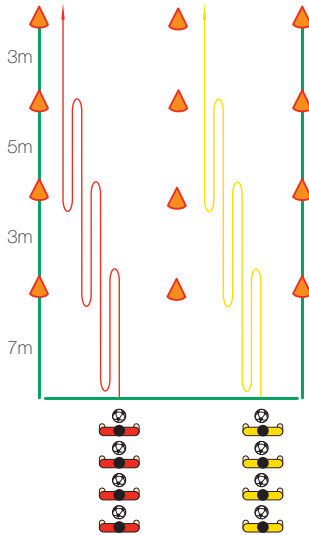

- Relays (to first line, then back 1, up 2)
 - without ball first
 - with ball

Progression: practice various turns at each cone

'Round the Block'

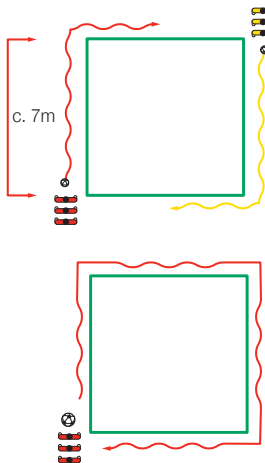

- Who will be first to get to opposite corner? (stop ball in front of player waiting there)
- Change direction regularly
- Or, one player at a time dribbles ball around whole square

Dribbling under pressure:

- one player dribbles around two sides, chaser runs around four sides.
- who gets to the finish line first?
- change direction/change roles
- If too easy for dribbler, chaser only runs around 3 sides
- keep finish line clear for safety

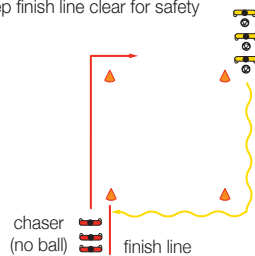

The Middle

'Round the Pyramid'

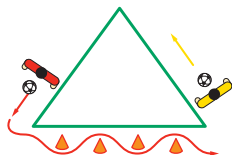

'Zig-zag cones'



Various 'Free' Practices

- In a square (dribble around the square with your ball, on my signal e.g. stop ball dead with sole of foot; stop it then run to another ball and start dribbling again; change direction using the outside of your foot; etc)

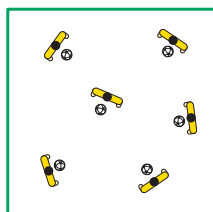

- Coach can suggest dribbling variations: left foot only, right foot only, outside of feet only, inside of feet only, etc.

'Protect and Pounce'

- Players dribble inside a square, protecting their ball from other players while trying to pounce on other players' balls (kick it out of the square). If successful in kicking one out of the square, award yourself a point. Call out when you get 3 points, 'Winner!'. When your ball is kicked out, fetch it then join in again.

Progression – when your ball is kicked out, stand just outside square and juggle till we get a winner, then all in to start again.

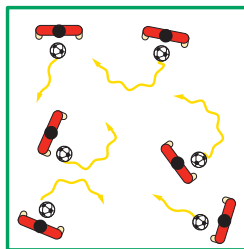

The Middle

'Round Them Up'

- 3 players dribble their balls inside a square. On signal, yellow player tries to 'round up' all 3 balls, by kicking them out of the square. 30 seconds to 'Round Them Up'. Develops change of speed and direction, and introduces concept of 'shielding'.

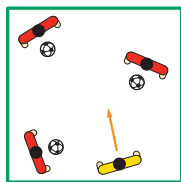

'Sheepdog'

- 1 'sheepdog' in a grid waits halfway up; 3 'sheep' set off simultaneously, trying to dribble the ball across the far line without having their ball kicked out of the grid by the 'sheepdog.' Doing so gets your team 1 point. If you get to the line, or your ball is kicked out, return to start line and wait till all 3 are ready to set off again. Continue till 'sheepdog' gets 3 points (kicks ball out of grid 3 times); how many points did the 'sheep' get?; new 'sheepdog' and start again.

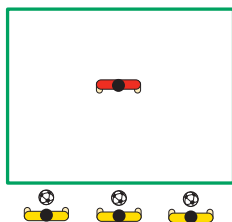

Most of the above will develop, by necessity, various ways of changing direction with the ball. However, it is also a good idea to reinforce some of these ways by means of short, concentrated practice:

- **'HOP AND STOP'** – while running with the ball close to you, do a little jump off one foot; before landing on that foot, stop the ball with the sole of the other foot; then land and turn back where you came from, taking the ball with you.
- **'HOOK'** the ball back behind the standing leg – while running with the ball close to you, turn back where you came from, in the act of turning, use one foot to 'hook' the ball behind the leg that is planted on the ground.
- **'CUT' THE BALL BACK** – using the outside or inside of the foot, turn and run back with it.

Practice should progress from unopposed, to passive opposition, to limited pressure, to full pressure.

The Middle

1v1

This refers to the skill of getting away from or getting past an opponent with the ball. In other words, while keeping possession of the ball, a player eliminates an opponent who is marking her, or stopping her going forward.

A player may use a number of methods to do so, such as:

- a change of pace
- a fake
- a feint
- any kind of 'trick'

In a single professional match, there are often over 200 1v1 contests, many of which could be better exploited by players with good 1v1 skills.

It has often been said that Australia does not produce enough 'exciting' or 'creative' players; Grassroots coaches can help develop more of these players by providing opportunities for kids to practice these skills and by encouraging players to 'express themselves'.

Perhaps the most important aspects to this are philosophical ones, which determine your attitude:

- **never criticise a young player for attempting to beat an opponent.** Even at the highest level, players often fail when trying to do so. If a player is afraid of criticism, he will become stifled and will always pass the ball instead.
- **accept that sometimes your team will lose possession when one of your players tries to beat the defender;** remember, at this stage, winning is not the objective, developing skilful players is.
- **give plenty of praise to players who are successful in beating an opponent.** This will reward that decision and stimulate others to do the same.

We need to establish a 'culture' in which this facet of play is encouraged. Only then will there be a real increase in the number of 'gamebreaker' players produced.

Grassroots coaches can be the catalyst for a major change in the type of players being developed in this country.

'Players with good 1v1 skills can often make the difference in a game, creating goal chances even though outnumbered by opponents.'

Alfred Galustian, Internationally renowned skills coach, technical advisor to Arsenal Football Club Academy, English Football Association and Japan Football Association.

The Middle

1v1 games and practices by their very nature also help improve agility and co-ordination. Also, players who become adept at 1v1 skills tend to gain an increase in confidence. This confidence greatly enhances their self-esteem and can be a major factor in helping players develop to an elite level.

Example:

Introduce concept of the 'fake' (best done in individual player squares)

- Sweep one foot low behind a static ball, step on that foot, then move the ball out to the other side using the other foot. If sweeping with right foot, make sure ball is slightly to your right (and vice versa).
- As above, but now sweep low around the front of the ball (harder).

These fakes are best developed in a large square, where players run with the ball, perform a fake and move on.

Teach The Individual – Tactics Will Come Later

- Don't worry about 'positions' or 'team strategies.'
- Encourage the players to express themselves, to try to dribble rather than always to pass the ball.
- U-6 to U-10 is the time for the player to learn how to master the ball. He/she needs to feel comfortable receiving it, running with it, etc. This should be the main focus of your training.

Ball each in one square – Variations

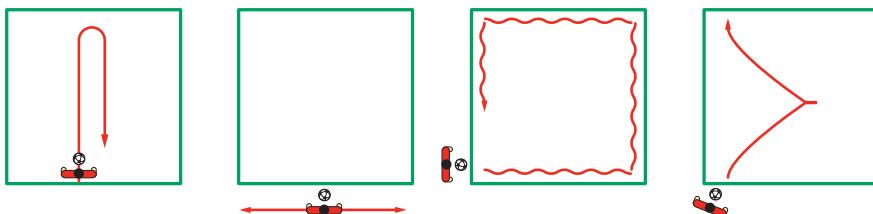

The Middle

1 v 1 – Practice Set-up

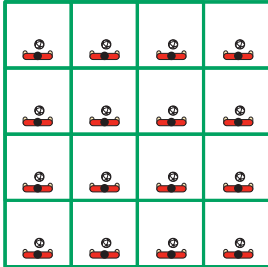

- Various moves (when demonstrating, remember your right is their left)
If necessary, a player can demonstrate in the coach's square

1 v 1 – Practice Progression

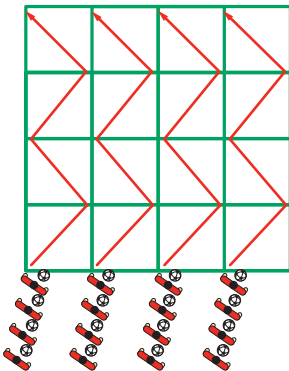

e.g. left foot fake
right foot fake
left foot fake
right foot fake

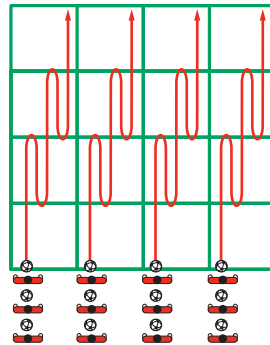

Various changes of direction.

You can also use some of the relay set-ups in 'General Movement' to practice 1v1 skills.

The Middle

Change of Direction - Practice

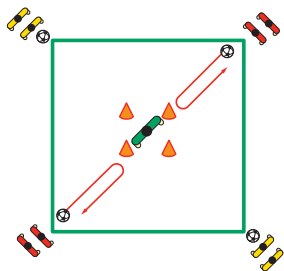

- Reds dribble to nearest cone, change of direction, then to back of line
- Then Yellows go etc.
- Coach observes, praises, controls from middle square

Faking Practice - Two at a Time

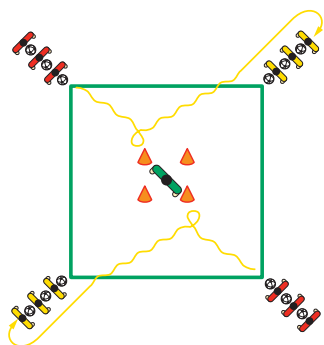

- Players from Red lines dribble, fake right and run to left
- Then Yellow lines go etc.
- Coach observes, praises, controls from middle square

Faking Practice - Four at a Time

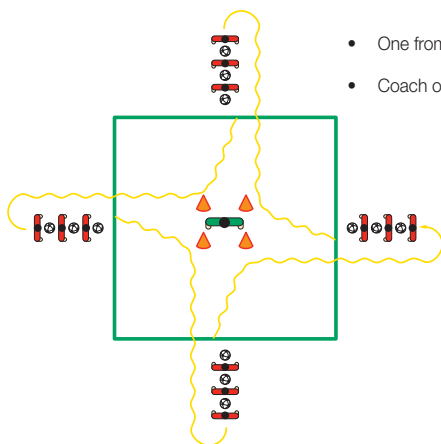

- One from each line
- Coach observes, praises, controls from middle square

The Middle

1 v 1 - Game

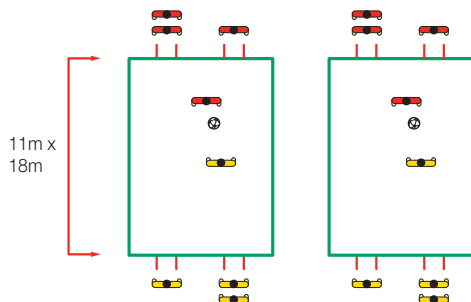

- 2 goals to score in, 2 goals to defend
- safety (no slide tackles, avoid collisions, if using posts, warn players not to stand behind them)
- 'ball boy' role for spare players
- 'try to trick her'
- short time 30-45 secs

1 v 1 v 1 - Game

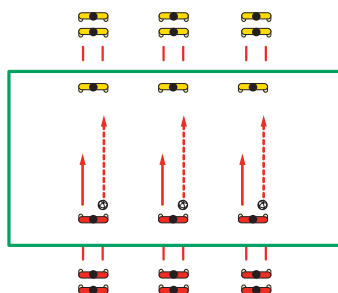

- red players play ball to yellow players to start
- three 1 v 1 games at once
- score/defend all 3 goals
- head up!
- if goal is blocked, fake and attack another one

1 v 1 - With Support

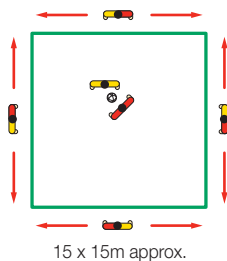

- 1 v 1 keep ball off opponent
- can use outside players - 2 touch (later 1 touch)
- head up!
- good for 'when to dribble', 'when to pass', 'give and go' etc.

The Middle

1 v 1 - Either Side Of The Line

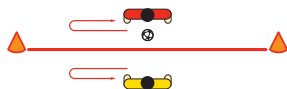

- red faces yellow with ball at her feet
- red and yellow must stay on their own side of the line, yellow cannot touch ball
- red uses fakes and changes of direction to try to beat yellow to either cone

1 v 1 - Short Or Long

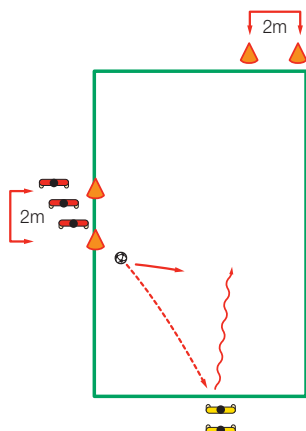

- red serves ball to yellow then defends
- yellow tries to beat red and dribble through either goal
- 3 points for far goal
- 1 point for near goal

Serve and Defend

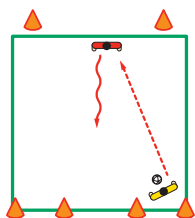

- Yellows - serve ball then defend two small goals, Reds - dribble through either small goal for a point, (if Yellow wins ball, can pass through big goal at far end for a point)
- return to same end. Keep score in set time, reds v yellows (then change roles)
- OR change ends after each go, keep personal 1 v 1 score

The Middle

Coach Serves – 1 v 1 Contest, Two Goals

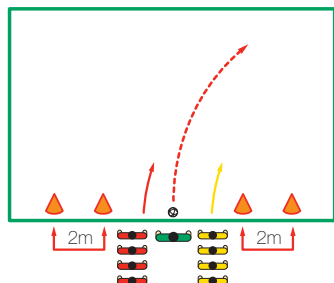

- Coach serves ball
- 1 v 1 contest
- player who gets to ball first tries to score in either goal
- if defender wins it, he too can score in either goal

Variation:

- number players 1 to 4
- coach calls a number at random or calls two or more numbers (2v2, 3v3, etc)

Pairs In A Square

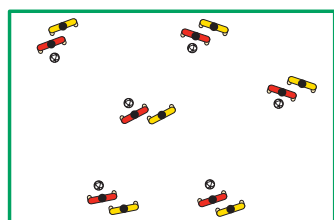

- red dribbles ball around square shadowed by yellow partner
- when coach calls, reds try a fake or change of direction against yellow (yellow shadows, but doesn't try to win ball) then passes to yellow, who waits for next call to do the same

Progression:

- yellow shadows, then on coach's call can try to win ball while red is faking or changing direction

1 v 1 Diamond Drill

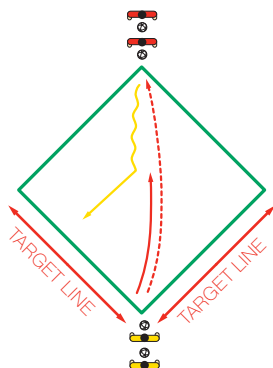

- 10-15m diamond
- yellow serves the ball to red, then tries to stop him dribbling ball over either target line
- red uses fakes, changes of direction to lose the defender
- defender moves to far end to wait turn as attacker, attacker joins defenders line

The End



1. Shooting Games

2. Small-sided Games



The End

Shooting Games

Scoring goals is the main objective in football; the game is in essence a competition between two teams, and the team that scores the most goals is the winner!

As the game has evolved, it has become harder and harder to score goals. That is why, in the transfer market for professional players, the most money is always paid for proven goal scorers: the match winners!

The more young players practice the act of goal scoring, the more it becomes an acquired habit that can be used in a game.

In addition, the feeling of scoring a goal, of seeing the net bulge as the ball goes in, is perhaps the sweetest of all the sensations the game offers players.

By providing regular opportunities for goal scoring, both in small-sided games and by use of shooting games and practices, grassroots coaches will:

- make sure young players understand what the game is really about.
- give all players the thrill of scoring goals.
- provide real high-motivation activity.
- help ensure Australia produces more players with an innate sense of how to score goals and the ability to do so.

'The learning process must be focussed on developing those qualities that are needed to learn to play a simplified match (4v4, 7v7, etc) and not on, taking in to account the limited hours of training, less important training activities for these age-groups'

Rinus Michels, Dutch coaching legend, FIFA 'Coach of the Century'

The End

Simple Shooting

- Rotation practice (feed from diagonally in front)

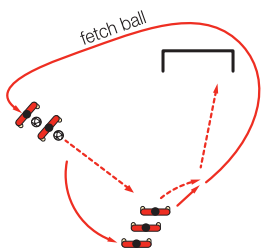

- serve - receive and shoot - fetch - serve
- NO Goal keeper (BIG GOAL or SMALL GOAL)

Competition: 2 parallel groups, first to 10 etc.)

- As above, but feed from behind – ‘feed – turn/shoot – fetch’

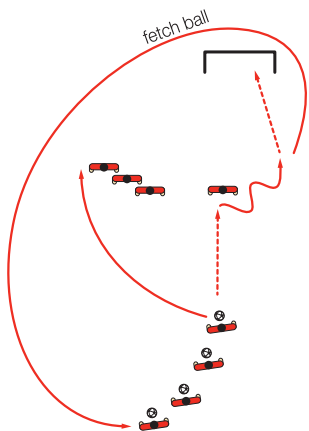

The End

'Pass To Self, Shoot, Dribble' - Circuit

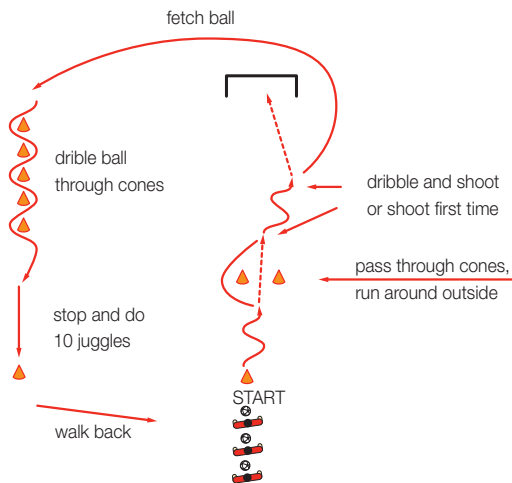

'One From Two'

- Dribble to line, stop it, then shoot at either of the two goals. A 'keeper' stands between the two goals and tries to stop balls entering either of them.

Progression: Don't stop ball, but shoot on the run

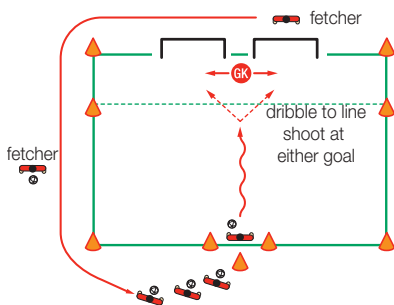

- a) stop on line, then shoot (later, dribble and shoot on the run)
- b) 'GK' stays for 5 shots, then change OR after shot, become 'GK'. 'GK' becomes fetcher, fetcher dribbles ball back to start

The End

'Up the Ladder'

- Dead-ball shooting competition.
- Set up pairs of cones at increasing distances from a small goal (or a larger goal with a keeper). Each player attempts to score from the closest line first; if successful, take next shot from line 2, and so on. EITHER: 1st to score from line 3 wins, then start again, change keeper (if necessary); OR, First group to score 5 goals wins; change keeper (if necessary) and start again.

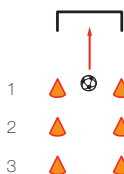

'Feed and Chase'

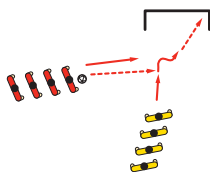

- small goal or larger goal with GK
 - red serves the ball parallel to goalline, then defends
 - yellow runs to ball, controls then shoots or shoots first time
 - change sides

'Shoot, Chaser From Behind'

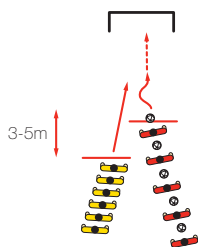

- when red is ready, he dribbles forward and shoots before yellow can tackle him
- yellow cannot cross the line before red touches the ball

Progression:

- red can use fakes to confuse defender, as long as he doesn't move the ball
- keep score (either 'teams' or 'individuals')
- change sides

The End

'1 v 1 Shooting Game'

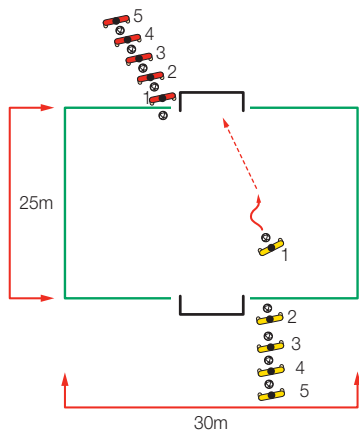

- yellow 1 dribbles and shoots
- as soon as he shoots, red 1 dribbles forward, yellow 1 turns and defends
- when red 1 shoots, or loses the ball, yellow 2 dribbles forward, and red 2, defends and so on

Progression:

- If defender wins the ball, he can turn and attack again, chased by player who lost the ball. Sequence continues.
- Requires high level of concentration.

'Circuit Shooting Practice'

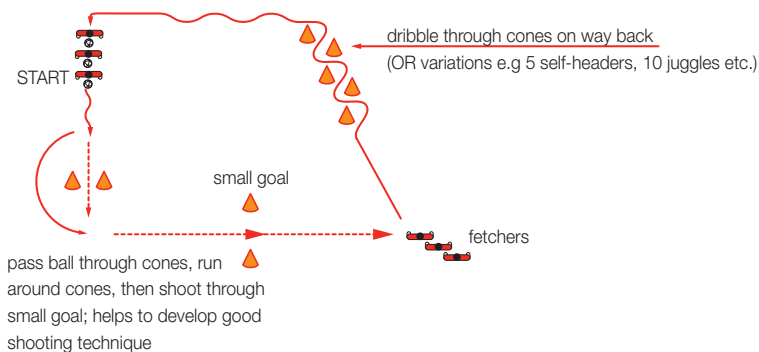

Remember to plan so that players don't have to wait too long to be involved. If necessary, set up two areas doing the same practice (safe distance apart; shots not directed at other group).

You may need to consider an effective method of ball retrieval. It is not productive if the practice keeps having to stop due to lack of balls. (The first and obvious solution is to make sure you have a plentiful supply of balls.)

Options:

- parents as ball-fetchers
- one or two players as fetchers, but constantly rotated (very short period of time as fetcher). Example – fetch ball, dribble it back through a slalom course, join line for next pass or shot (the player whose ball you fetched replaces you as fetcher.)

The End

Small-sided Games

There is a huge amount of international evidence to support the use of small-sided games in developing young players' interest and ability in football. Most developed nations recommend and implement small-sided games.

Put simply, the reasons are:

- Less players equals more touches, more involvement, more fun.
- The game must not be too complicated while they are learning it.

LET THEM PLAY!

When it comes to the game at 'the end', follow these guidelines:

- Simple rules
- Even numbers
- No conditions – just the game!
- Don't coach them, observe them

In this way, they will gradually learn the concepts of the game, such as 'we try to score in that goal, and we try to stop them scoring in this one.'

Some suggested rules:

- normal kick-off to start game
- after goal is scored, goal-kick for team that conceded the goal
- kick-ins (or dribble-ins) instead of throw-ins
- no offside
- direct free-kick for any infringements
- '3m/3 second' rule for all restarts (nearest player must be at least 3m away from the ball; you have 3 seconds to kick it in, etc)

SAFETY FIRST

The safety of the players takes precedence over all other considerations when planning and organising games, as with all parts of a training session.

The End

Why small-sided games?

'Children are not small adults. At the earliest stage, a child's interest in the game called football must be gradually developed.

Then the essential rules concerning the playing fields, the ball, the duration of the game, the number of players must be adapted according to the individual age-group.'

Statement from FIFA, the world governing body for football.

'Expecting a child to comprehend and respond to the complex situations in the full 11v11 game format will only beget frustration and feelings of failure.'

'Learning to understand the complex game of football can be best achieved through the practice of a logical progression of simplified games, with a gradual increase in the number of players on the teams.'

Horst Wein (World-renowned mentor of football coaches)
'Developing Youth Football Players'

'The children are more important than the activities in which they are engaged. The game is not the thing, the child is.'

UK Dept Of Education And Science, 'Physical Education for ages 5-16'

'Nature decrees that children should be children before they become adults. If we try to alter this natural order, we will reach adulthood prematurely but with neither substance nor strength.'

Jean J. Rousseau

'Moving step by step, you may travel great distances'

Anonymous

The End

The following pages contain some simple game formats for you to follow.

Sizes of fields, goals, etc, are only a guide; experiment until you find the sizes that suit the age and ability of your players.

4 Small Goals



	Width	Length
2 v 2	12-15m	15-22m
3 v 3	15-25m	25-35m
4 v 4	20-25m	35-40m

Goal Width 2-3m
(use cones, flags, bibs, etc as posts)
REMEMBER SAFETY

- no keepers
- realistic game practice
- 2 goals at each end prevents defenders simply blocking the goal
- develops vision and switching the attack

4 Small Goals (And Scoring Zones)

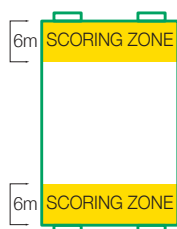

	Width	Length
3 v 3	15-25m	25-35m
4 v 4	20-25m	35-40m

Scoring zones are kept free of players until the ball enters the zone.

- prevents players simply standing in front of their goal to stop opponents scoring

- Creates space behind last line of defence
- Encourages dribbling and combinations to get into the scoring zone
- Encourages passing into space for team mate to run onto
- No keepers

End Line Game

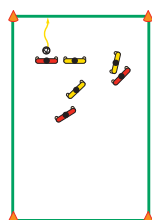

	Width	Length
2 v 2	12-15m	15-22m
3 v 3	15-25m	25-35m
4 v 4	20-25m	35-40m

- no goals or keepers
- score by either:
 - a) dribbling ball over opponents end-line or
 - b) stopping ball on opponents end-line
- encourages dribbling and 1 v 1 skills
- develops keeping possession until there is space to exploit

The End

End Line Game Variation

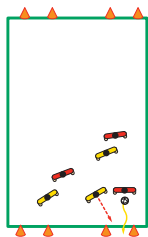

	Width	Length
2 v 2	12-15m	15-22m
3 v 3	15-25m	25-35m
4 v 4	20-25m	35-40m

Goal width 3-5m

- score by either:
 - a) dribbling ball through either of the opponents' goals or
 - b) stopping ball on either of the opponents' goal-lines
- increased level of difficulty compared to basic end-line game

2 Medium Size Goals (No Keepers)

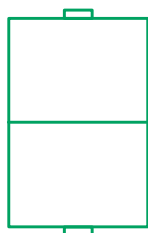

	Width	Length
2 v 2	12-15m	15-22m
3 v 3	15-25m	25-35m
4 v 4	20-25m	35-40m

- encourages players to look for scoring opportunities as goal is unprotected
- goals only count if scored from inside the opponents half

2 Big Goals (With Keepers)



	Width	Length
2 v 2	12-15m	15-22m
3 v 3	15-25m	25-35m
4 v 4	20-25m	35-40m

Goal Size

Big enough to score plenty of goals

Keeper Zone

To extend 3-8m depending on age and ability. THINK SAFETY.

- keeper zone each end for safety; only goalkeeper is allowed in zone. Prevents collisions and other injuries.
- rotate goal keepers regularly.
- score goals!
- HAVE FUN!

The End

3 Team Football

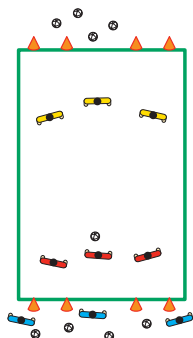

- more suitable for older age-groups
- can be used for most game formats
- instead of 2 teams playing each other continuously, there are 3 teams with a constant 'on and off' concept
- (see diagram) reds attack yellows' goals, and try to score
- if reds score they are now off. Yellows take nearest ball and attack the end where the reds came from; blues now come onto the field and defend against the yellows. Reds wait behind the goals they were attacking and so on.
- if the yellows win the ball from the reds, they immediately attack the blues (reds jog off to wait behind the goals they were attacking)

Variation:

- If you score, you stay on, and immediately attack the other goals. The team conceding the goal gets back behind the goals they were defending.
- good set-up for keeping 3 teams busy
- develops concentration

The End

Managing Your Group Size

When it comes to game time at the end of the session, it is important to keep everyone occupied and interested.

Here are some suggestions;

- 2 Teams playing on one field, spare players rotated in regularly

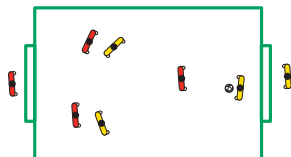

- 2 Teams playing, a 3rd team works on individual ball exercises (rotate teams regularly)

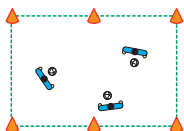
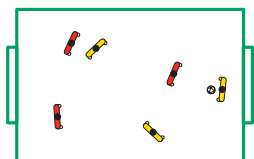

eg practice juggling

- 2 Teams playing on one field, and 2 teams playing on another field. Rotate teams regularly (if necessary, change team-mates too) Coach needs to stand where he can see both groups.

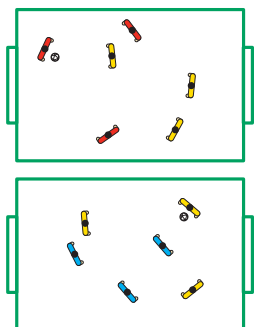

- 3 Team football (see page 77)

Your best option is to involve every player in the game, whenever possible.

How To Keep The Fun Going

Making Competition Interesting

- Number of goals scored (traditional A versus B scenario)
- Number of goals scored in a set time period (allows a number of 'games' to be played within the same set-up, giving both teams several opportunities to be the 'winner.' The coach can maintain interest: 'That's 3 points to the red team, now we'll play for 3 minutes and this game is worth 5 points, etc.')
- The 'human stopwatch.' (How many goals can this team score before every member of the other team completes 5 circuits of the slalom dribble course?, etc) Only applies to shooting games.
- More than 2 teams competing (reds v blues v yellows) Only applies to shooting games.
- 'Scoreboard.' (Use physical items such as cones or bibs which are collected or moved to a certain place every time a goal is scored, so players can 'see' what the score is. If you have the larger 'traffic' cones, they can be knocked down or stood up to record a goal. 'The reds have 5 cones standing there, the blues have 5 there; when you score, go and knock one of your team's cones down; let's see which team knocks all their cones down first.'



The End

Cool Down

At the end of the session, a cool down involving a gradual drop in activity level and some extra stretching is the best way to finish the session. Going from a highly active state to a complete stop can be detrimental. Recovery is slowed and muscle soreness can result, so finish each session with a light activity. It might be a light jog or walk across the park and back or a skill activity of low intensity. Only 1 or 2 minutes is needed. A light cool down activity is more important for older players (9-10) who have probably trained at a higher intensity. But again, only a few minutes are required.

Finish the session off with a few stretches. For younger players (6-7) four or five stretches, each lasting 10 seconds should be sufficient. Only 4 or 5 minutes is required. For older players, a few extra stretches, held for slightly longer is a good idea as they have probably trained at a higher intensity. Again keep it short and use the time to teach the players to stretch correctly.

Players of this age do not need to do the cool down for the same reasons as older or elite players. However getting into the habit at a young age is a good idea. This is also a good time to give players feedback and encouragement or information they may need, such as when the next game is or any administration information they may need to pass on to parents. You should also use the time to give an evaluation of the session ('remember how we tried to control the ball when it came to us...'; etc.) and maybe suggest some 'homework' ('before our next training session, try to practice what we did at the start of today's practice; watch me demonstrate again while you are stretching' etc).





























Putting It All Together

Planning Age-Appropriate Sessions

Simply choose one or two exercises from each section.

The number of balls indicates the importance of each component to that age-group. You do not have to use all activities in every session (see 'sample sessions' Pages 85-87). For example, with an U-8 team, you may decide to use only a 'Tagging Game' for 'The Beginning', 'Passing and Receiving' and 'Dribbling' for 'The Middle', and just a 'Small Sided Game' for 'The End'.

Use the guidelines below to help you choose for your particular age-group (NB. This is only a guide; some groups may require more, or less, challenging activities).

	ACTIVITIES	U-5/U-6	U-7/U-8	U-9/U-10
THE BEGINNING 	General movement			
	Tagging games			
	Ball mastery exercises			
THE MIDDLE 	Passing and receiving			
	Dribbling			
	1v1			
THE END 	Small-sided games			
	Shooting games			

FOR EASE OF REFERENCE, THIS CHART CAN ALSO BE ACCESSED ON THE BACK COVER FOLD-OUT SECTION

Session Timeline

60 MINUTE SESSION AS AN EXAMPLE

Greet every player. Ask about school, family etc. Quick intro chat on last session and today's. Early arrivers can start juggling etc.

No need to clock-watch; give or take a few minutes

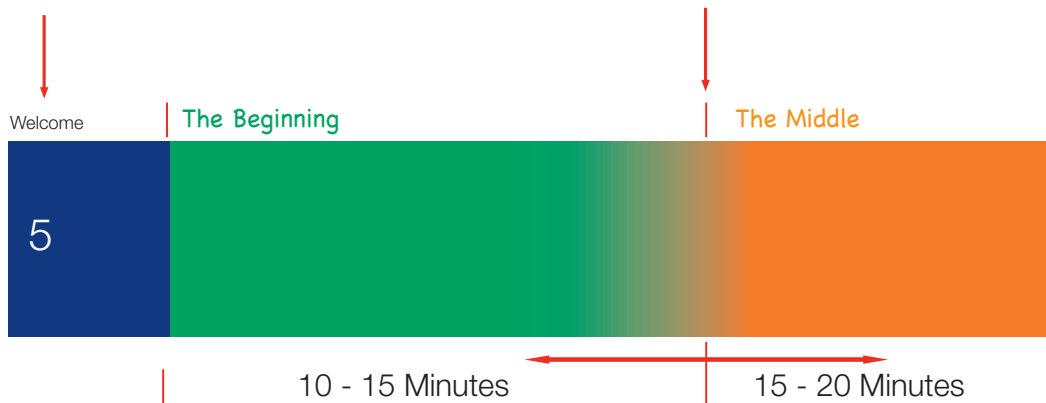

ALL TIMES ARE GIVEN AS A GUIDE ONLY

NOBODY IS TIMING YOU WITH A STOPWATCH!

HOW LONG TO TRAIN?

5-6-7 Year-olds 45-60 minutes

8-9-10 Year-olds 60-75 minutes

Session Timeline

Try not to cut game time short.
Making it longer is OK.

Cool-down; session recap; Maybe a fun activity like 'How many of you can score a penalty past me?' 'Lets have a quick juggling competition'.
Praise the whole group; 'Great Session! High-fives! See you next time.'

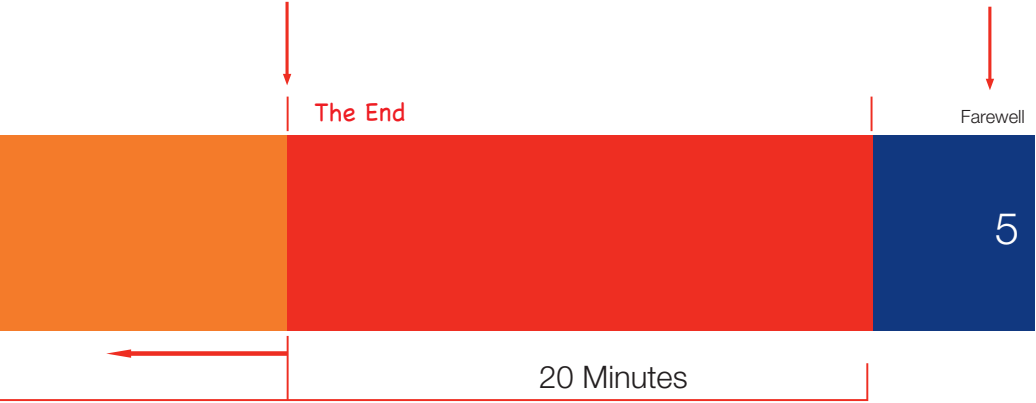

Sample Sessions

For your convenience, we have put together some sample 6 week programs to get you started.

There is one each for U-5/U-6, U-7/U-8 and U-9/U-10.



Sample Sessions U-5/U-6

	BEGINNING	MIDDLE	END
1	General movement 'SPELLING TEST' 'LINE DANCING' Tagging games 'PAIRS TAG'	Passing and receiving 'FORMULA 1' Dribbling 'CRISS-CROSS' 'ROUND THEM UP'	Small-sided game 4v4 (4 small goals)
2	General movement 'SPELLING TEST' 'LINE DANCING' Tagging games 'PAIRS TAG'	Passing and receiving 'FORMULA 1' Dribbling 'CRISS-CROSS' 'ROUND THEM UP'	Small-sided game 4v4 (4 small goals)
3	General movement RUNS AND JUMPS 'MARTIN TYLER' Tagging games 'ME AND MY SHADOW'	Passing and receiving 'THROUGH THE GATE' (AND PROGRESSION) Dribbling 'ROUND THE BLOCK' 'ROUND THE PYRAMID'	Shooting game 'UP THE LADDER' Small-sided game 4v4 (2 goals)
4	General movement RUNS AND JUMPS 'MARTIN TYLER' Tagging games 'ME AND MY SHADOW'	Passing and receiving 'THROUGH THE GATE' (AND PROGRESSION) Dribbling 'ROUND THE BLOCK' 'ROUND THE PYRAMID'	Shooting game SIMPLE SHOOTING Small-sided games 4v4 (2 goals)
5	General movement SIMPLE RELAYS Tagging games 'STICK IN THE MUD' Ball mastery THROW IT UP (variations)	Dribbling 'ZIG-ZAG CONES' 'SHEEPDOG'	Small-sided games 2v2 (4 small goals) 4v4 (4 small goals)
6	General movement SIMPLE RELAYS Tagging games 'STICK IN THE MUD' Ball mastery THROW IT UP (variations)	Dribbling 'ZIG-ZAG CONES' 'SHEEPDOG'	Small-sided games 2v2 (4 small goals) 4v4 (4 small goals)

Sample Sessions U-7/U-8

	BEGINNING	MIDDLE	END
1	General movement SAMPLE WARM-UP 1 P18 Ball mastery JUGGLING	Passing and receiving 'THROUGH THE GATES' Dribbling 'FREE SQUARE'	Small-sided game 4v4 (4 small goals)
2	General movement SAMPLE WARM-UP 1 P18 Ball mastery JUGGLING	Passing and receiving 'THROUGH THE GATES' Dribbling 'FREE SQUARE'	Shooting game '1 FROM 2' Small-sided game 4v4 (4 small goals)
3	General movement 'FETCH AND CARRY' 'CRAB POT' Tagging games 'CATCH THE TAILS'	Dribbling 'PROTECT AND POUNCE' 1v1 'PAIRS IN A SQUARE'	Small-sided game 4v4 (4 small goals)
4	General movement 'FETCH AND CARRY' 'CRAB POT' Ball mastery JUGGLING	Passing and receiving '3v1 IN SQUARE' Dribbling '1-2 RELAYS'	Shooting game '1 FROM 2' Small-sided game 4v4 (4 small goals)
5	General movement 'FEATHER THE NEST' 'BRIDGES' Ball mastery JUGGLING	Passing and receiving '3v1 IN SQUARE' Dribbling '1-2 RELAYS'	Small-sided game 4v4 (2 goals)
6	General movement 'FEATHER THE NEST' 'BRIDGES' Tagging games 'CATCH THE TAILS'	Dribbling 'PROTECT AND POUNCE' 1v1 'PAIRS IN A SQUARE'	Shooting game 'FEED AND CHASE' Small-sided game 4v4 (2 goals)

Sample Sessions U-9/U-10

	BEGINNING	MIDDLE	END
1	General movement 'EMPTY IT, FILL IT!' Ball mastery JUGGLING	Passing and receiving 5v2 Dribbling 'FREE SQUARE' 1v1 '1v1v1 GAME'	Small-sided game 4v4 (4 small goals)
2	General movement 'EMPTY IT, FILL IT!' Ball mastery JUGGLING	Passing and receiving 5v2 1v1 '1v1v1 GAME'	Small-sided game 4v4 (4 small goals) Shooting game 'FEED AND CHASE'
3	General movement SAMPLE WARM-UP 2 P19 Ball mastery BALL FEELING	Passing and receiving '4v1 ACROSS SQUARE' 'NUMBERS GAME ' (AND PROGRESSION) 1v1 '1v1, SHORT OR LONG'	Small-sided game 4v4 (2 goals)
4	General movement SAMPLE WARM-UP 2 P19 Ball mastery JUGGLING	Passing and receiving '4v1 ACROSS SQUARE' 'NUMBERS GAME ' (AND PROGRESSION) Dribbling 'FREE SQUARE' 1v1 '1v1v1 GAME'	Small-sided game 4v4 (4 small goals) Shooting game 'FEED AND CHASE'
5	General movement 'ROBIN HOOD' Ball mastery JUGGLING	Passing and receiving 'PASS AND FOLLOW SQUARE' 1v1 '1v1v1 GAME'	Small-sided game 4v4 (4 small goals)
6	General movement 'ROBIN HOOD' Ball mastery BALL FEELING	Passing and receiving 'PASS AND FOLLOW SQUARE' 1v1 '1v1, SHORT OR LONG'	Small-sided game 4v4 (2 goals) Shooting game 'CIRCUIT STYLE'

Circuits

Coaches may wish to experiment with the 'circuit' or 'tabloid' approach to organising training sessions.

This method involves the setting-up of several practice/game areas. The players rotate from one to the next (i.e. four players at Station 1, four players at Station 2 and four players at Station 3).

Certain coaches and certain groups of players may prefer this approach; some coaches may wish to use circuits as a 'variation' once every six weeks or so, to give the players a 'change of scenery.' Following the guidelines in this book, coaches will be able to devise appropriate stations for their players, if they so desire.

Circuits are best used in 'the middle' section of the session, so that the general movement and introductory components remain in 'the beginning', and the game remains the focus in 'the end.'

Correcting a player is valuable; encouraging a player is priceless

Managing Children's Behaviour

Organising groups of youngsters and getting them to follow instructions can sometimes be a challenging task. However, many potential problems can be avoided by using the 'tools required for the job' outlined on pages 7-9.

Remember,

PERSONAL SKILLS and ORGANISATION SKILLS will be your main tools.

- If you're enthusiastic, they probably will be.
- If the session is planned and set up in advance, there is less chance of the kids getting distracted.
- If you are patient and keep smiling when things aren't quite working for you, you'll never lose their respect.
- Try not to over-react when kids, especially 5 and 6 year-olds, don't do as you ask immediately. Remember, they are not deliberately trying to spoil your session – they are just being kids!

Praise is best

- Keep praising kids for good performance and good effort
- Give more attention to those who are getting on with things, rather than to the 'attention-seekers'

More activity, less misbehaviour

- If the session is well-planned, well-organised and enjoyable, the kids will be too busy PARTICIPATING.
- When problems arise, first ask yourself 'is this my fault?'. The cause of the unrest may be you ('have we been doing this for too long?', 'is this too hard for them?', 'have I been talking too much?', etc)

How to deal with misbehaviour

- Stay calm and in control
- Use comments like 'Melissa, that's not what we're meant to be doing, is it?'
- Avoid personal jibes such as 'You are a silly girl.' Don't abuse the child, but draw attention to the behaviour; instead, say 'That's a silly thing to do.'
- It is not a good idea to punish everyone for the misbehaviour of one child.
- Avoid using physical activity as a punishment (e.g. 'run twice round the field', 'do twenty push-ups). Exercise should be seen as fun, not a chore.
- Sometimes, simply standing nearer to the child and looking at him is enough.
- Find something to praise or encourage ('keep working hard, Keegan') or ask how things are going ('how many times have you passed the ball through the gates, Keegan?')
- Before acting on it, try to find out if there is another reason why he is not following instructions, e.g. can't do the exercise; injured; upset about something, etc.

Managing Children's Behaviour

If further action is required:

- In a calm manner, ask the child 'do you think you should be doing that?', and maybe ask 'what should you be doing instead?'
- Without losing your cool, ask the child to change what he has been doing, and follow the group instructions.

If you're still having problems:

- 'time out' is a simple way of dealing with the child who has refused to behave appropriately.
 1. keep the 'time out' brief, but long enough to have an effect.
 2. make sure the 'time out' zone is not too far away, so you can keep an eye on the child.
 3. when the child tells you he is prepared to follow group instructions, he may return to the group.
- when removing a child from the group, do not physically move or take him there (i.e. don't grab or drag him). Avoid long lectures, and use firm but calm words. Don't hold a grudge against him – he's just a child.



Making best use of your training area

'A player's time is a precious commodity – coaches should never waste it.'

Most coaches of junior players have to work in a limited area. Given the age of the players, this is not really a problem; the challenge for you as a coach is to make best use of the area, and not to keep the kids waiting while you set up the next practice.

The 'Grassroots Training Field' concept is a simple way for coaches to give players a well-organised and effective practice session.

An ideal area for kids would be in the vicinity of 24 x 32 m. This allows for easy division into smaller, age-appropriate areas. However, if your available area is slightly different, don't worry.

In a nutshell, the concept is this:

- Start with lots of cones, and lots of small areas, planned to suit your 'beginning' activities.
- As the session progresses, you will gradually remove cones to reveal larger areas for 'middle' activities'.
- By the end, you will often have removed all the cones except the perimeter cones, which leaves you a field for your 'end' activity, e.g 4v4 game.

The point of it is: you don't have to find a space for the next practice, measure it out, then walk around putting cones down (time-consuming for you; time-wasting for players); simply remove cones and the next area is ready (you look organised and professional; the players stay interested and motivated)

There are many different permutations, which are influenced by the age and ability of your players and the particular activities you have planned.

A 24 x 32 m area could be divided into 12 squares of 8 x 8m, or into quarters of 12 x 16m which can be divided again in various different ways. You decide, depending on what you have planned. The '4 quarters' option might suit you if you are going to need 4 larger areas in the 'middle' part; the '12 squares' option might be better if you are going to need a large number of small areas in the 'beginning' part, for example.

You should never feel restricted by it. If you end up having to make some slight adjustments to a few cones, don't worry! As long as it's a quick change over, you are still taking advantage of the main concept – no need to waste time measuring out and placing large numbers of cones.

'Unfortunately, experience has shown us that the teaching of technique is all too often neglected, with emphasis placed instead on the instruction of team tactics and physical condition'

'FIFA Coaching'

What are the Secrets to successful kids coaching?

Plan the session

- Be clear how you will organise it (what areas to mark out, etc)
- Avoid over-planning (simple sessions are usually most successful)
- Some activities will need to be repeated for a few sessions (kids can pick things up better with some continuity, instead of constantly having to learn new activities)

Set up early

- Arrive before the players, and have it all set up (remember SAFETY CHECK)

Get things happening quickly

- Give clear and short instructions
- Use a demonstration whenever possible (make sure they are looking and listening; stand where there are no distractions behind you, and the sun is not in their eyes)
- Make sure you've been understood ('any questions?')

Try to be more of an 'organiser' than a 'coach'

- Let them play! (Avoid stopping them and talking too much)
- Remember, if you follow the guidelines from this book, the activity itself will usually be the 'coach.'

Enjoy yourself!

- Have fun with football (remember, it's a game – not a chore)
- Have fun with the kids (get to know them all, talk to them all)

Set some guidelines

- Let the kids and their parents know what you expect (behaviour, punctuality, etc)
- A parent's information night followed by a social dinner is a great way to deliver these important messages and then perhaps answer questions.
- You and the kids can make some rules and talk about what consequences might follow if they are broken (e.g. time-out)

Picking teams

- It's better if you just call out numbers (e.g. 'you're a 1, you're a 2, you're a 1, etc. OK, all the 1's over here, all the 2's over there.') rather than letting players pick teams. Being one of the last ones picked can damage a kid's self-esteem.

What are the Secrets to successful kids coaching?

WHY before HOW

- If players understand **why** they are doing it (i.e. how it relates to the game) they will be more enthused about learning **how** to do it. Use a brief explanation or, if possible, a quick demonstration to illustrate why the players might need to learn the skill they are learning.

KISS

- The 'Keep It Simple, Stupid' principle applies in many walks of life, and teaching football is no exception. Too many coaches hold the mistaken belief that the more complicated they make things, the more advanced their knowledge is perceived. But remember, a more complex practice, particularly with youngsters, is rarely a better one.

'Simplicity is genius'

Ron Greenwood, former National Coach of England.



What about defending?

At this stage of the players' development, we should be focusing on attacking aspects of the game. There are so many skills and techniques for a child to pick up, that spending time on defending (which can easily be taught at a later stage) is a waste of valuable learning time.

'It can take years to learn how to master certain technical moves and skills, but learning how to operate tactically within a system can take just a few weeks.'

'FIFA Coaching'

Remember, 'winning is not important' for kids so don't worry too much about stopping the other team scoring. Let them have fun trying to score themselves.

However, there may be occasions with older players, when you may wish to give some very basic tips as an introduction to the defensive part of the game.

Start by suggesting that the best thing to do when we don't have the ball is for each of us to look for an opponent.

Then, ask simple questions:

- **Can you stand between your opponent and your own goal?**
- **Can you stop him from scoring when he gets the ball?**
- **Can you take the ball off him?**
- **Can you stop the ball getting to him in the first place?**

These questions are of increasing complexity and should not be introduced all at once.

What about goalkeeping?

There is no specific goalkeeping content in this book.

The intention is to encourage grassroots coaches of 6-10 year-olds to concentrate on the general development of players, rather than any specialist positions (e.g. defender, forward, goalkeeper)

Within the book, there are opportunities in many of the games and shooting practices to use either a goalkeeper, or a rotation of field players in a 'keeper' role. At the earlier ages, this 'sampling' of goalkeeping is a valuable component in the development of game awareness. It also facilitates the identification of those youngsters who show a desire or talent for goalkeeping.

It is a sound idea to recommend a player who wishes to specialise in the position of goalkeeper to seek additional training with a qualified goalkeeper coach. Note that FFA's Coach Education Program includes two Goalkeeper Coaching courses for those Grassroots coaches interested in pursuing this area of the game.

There is often a temptation to allow children to specialise in goalkeeping too early, to the extent where they do not train with the other players. This often hinders their overall development and their ability to use their feet, a skill which modern goalkeepers need. Within your sessions, every player should participate in all activities.

REMEMBER!

At all times, put 'safety first' when using a goalkeeper in a game or shooting practice.

The Ten Commandments for kids' coaches

1. Like the children and get pleasure from their company.
2. Know them well.
(way of life, characteristics)
3. Serve as a mentor, but at the same time encourage initiative.
4. Be a little demanding, but show tolerance.
5. Be a listener, show that you are available.
6. Encourage a real communication with ALL your players.
7. Be 'in sync' with them.
(put yourself at their level)
8. Ensure that they have some free space for themselves.
9. Give them confidence and keep reassuring them.
10. Consider them as equal partners.

(adapted from 'Training Young Players', by the French Football Federation, and 'FIFA COACHING')

Try Not To...

- Shout non-stop from start to finish of the match, or at training.
- Treat youngsters like seniors.
- Stay too long on the same exercise or the same game.
- Criticise the player in front of the group.
- Talk for too long.
- Interrupt the session constantly.
- Conduct sessions that are not adapted to the age or ability of the players.
- Always do the same type of exercise on the same subject.
- Allow a gradual lowering of standards you set at the beginning, (lateness, etc)
- Forget the basics of the game.

(adapted from 'Training Young Players', by the French Football Federation, and 'FIFA COACHING')

FFA Statutes

Over recent years, FFA has undertaken extensive research and consultation to develop national regulations to ensure all participants across the country enjoy football on equal and fair terms. The introduction of a uniform framework will also ensure that respect and protection is provided for coaches, players and referees whilst assisting volunteers administer the game and removing some of the burden currently placed upon them. The regulations will enable FFA to be compliant with FIFA, the world governing body for football, together with their various Statutes and regulations. Football in this country will now be in line with the rest of the football world and FIFA.

Coaches, together with all other members of official football in Australia, are bound by the FFA Statutes which specify the rules and regulations for the administration of the playing, participating, coaching and officiating of football within FFA's jurisdiction.

These Statutes include the National Registration Regulations, National Code of Conduct, National Spectator Code of Conduct, National Disciplinary Regulations and National Grievance Resolution Regulations. They can be found on www.footballaustralia.com.au under the "Inside FFA" section and "Statutes".

Acknowledgements & References

Acknowledgements

- Tim Rogers, AIS Strength and Conditioning ('Warm-up and Stretching' section)
- Alfred Galustian
- Phil Moss, Manly Warringah FA (and the grassroots coaches of MWFA)
- Barry Walker, Bankstown District FA
- George Fallah
- Brian Dene
- Barbara Dene
- Ben Green
- Sophie Harris and Grant Muldoon, SLH

References

- 'FIFA Coaching Manual', FIFA
- 'Developing Youth Football Players', Horst Wein, Human Kinetics.
- Junior Sport Briefing Papers, Australian Sports Commission, 2005
- 'Playing for Life', Australian Sports Commission Resource Kit
- 'Modern Youth Training – Ages 5 – 12', German Football Federation (DFB)
- 'L'Entrainement des Jeunes', Football Federation Francaise (FFF)
- 'Futbol Infantil; Entrenamiento Programado', Carlos Borzi, Editorial Stadium, Argentina
- 'Coaching Under-8s', Royal Dutch Football Association (KNVB)
- 'Make Your Move', Alfred Galustian and Charlie Cooke
- The FFA Coach Education Program DVD
- 'A guide to developing Physical Qualities in Young Athletes', Kevin Giles, Lachlan Penfold and Anthony Giorgi (www.movementdynamics.com)
- 'Best Practices for Coaching Soccer in the United States', US Youth Soccer Association.
- 'Understanding Motor Development', David L. Gallahue, Brown and Benchmark
- Author's Own Notes

Where To Go From Here?

Survival Pack for Coaches

Grassroots coaches are encouraged to consult the 'Survival Pack for Coaches' developed by the Australian Sports Commission for beginner coaches of all sports and available via the link below:

<http://www.ausport.gov.au/coachofficial/tools/survivalpackcoaches/index.asp>

The content contained there covers topics such as:

- Risk management
- Child protection
- Working with parents / officials

The next step....

The next step for you is to enrol on a Junior Football Certificate.

For further information contact your State Federation via the contacts on Page 104 or go to the 'Coaching' Section at:

www.footballaustralia.com.au

Contacts

Organisation	Telephone	Email address	Website
Football Federation Australia 	02 8020 4000	info@footballaustralia.com.au	www.footballaustralia.com.au
Capital Football 	02 6260 4000	info@capitalfootball.com.au	www.capitalfootball.com.au
Football Federation Northern Territory 	08 8941 2444	info@footballnt.com.au	www.footballnt.com.au
Football Federation SA 	08 8354 1422	info@ffsa.com.au	www.ffsa.com.au
Football Federation Tasmania 	03 6273 3299	admin@footballfedtas.com.au	www.footballfedtas.com.au
Football Federation Victoria 	03 9474 1800	info@footballfedvic.com.au	www.footballfedvic.com.au
Football Queensland 	07 3420 5866	admin@footballqueensland.com.au	www.footballqueensland.com.au
Football West 	08 9422 6900	info@footballwest.com.au	www.footballwest.com.au
Northern NSW Football 	02 4964 8922	socceradmin@norsoc.org.au	www.northernnswfootball.com.au
Football NSW 	02 8814 4400	info@footballnsw.com.au	www.footballnsw.com.au

Session Timeline

Based on 60 minute session

Welcome
(5 minutes)

The Beginning
(10-15 minutes)

The Middle
(15-20 minutes)

The End
(20 minutes)

Farewell /
Cool down
(5 minutes)























Putting It All Together

Planning Age-Appropriate Sessions

Simply choose one or two exercises from each section.

The number of balls indicates the importance of each component to that age-group. You do not have to use all activities in every session (see 'sample sessions' Pages 85-87). For example, with an U-8 team, you may decide to use only a 'Tagging Game' for 'The Beginning', 'Passing and Receiving' and 'Dribbling' for 'The Middle', and just a 'Small Sided Game' for 'The End'.

Use the guidelines below to help you choose for your particular age-group (NB. This is only a guide; some groups may require more, or less, challenging activities).

	ACTIVITIES	U-5/U-6	U-7/U-8	U-9/U-10
THE BEGINNING 	General movement			
	Tagging games			
	Ball mastery exercises			
THE MIDDLE 	Passing and receiving			
	Dribbling			
	1v1			
THE END 	Small-sided games			
	Shooting games	